



 GERMAN
ENGINEERED

Garage Door Price List

PREMIUM GARAGE DOOR SOLUTIONS

APRIL 2025



Intelligent Door Solutions

UK
CA CE



Welcome to the Novoferm 2025 Price List

We're excited to introduce the Novoferm 2025 Price List, shaped by your valuable feedback. We've made some key updates to enhance our product offering.

Key highlights include:

Steel and GRP Up & Over Doors

Steel frames are now included as standard with all Steel and GRP Up & Over doors. No need to add them separately. We have removed the categories of Primary, Premium & Prestige from our steel door range.

Roller Doors

Novorol 77 & 55 roller doors now include boxes as standard, simplifying pricing. On Novorol 77 if you prefer no box or a half box, these options remain available on request.

Somfy Automation

All Novorol roller doors will now come with Somfy control units as standard, offering advanced automation. If you prefer Novorol 20 or Teleco control units, these remain available on request.

New Operators

The introduction of our new and improved ceiling mounted operators, Novomatic 443 & Novomatic 573 S alongside the Novoport Speed operator, the only side mounting operator on the market, exclusive to Novoferm.

Technical Information

Due to value customer feedback, we have reintroduced our technical information guides into our brochure to assist all our customers with key information about our products.

We'd like to thank you all for your continued support in making Novoferm the trade supplier of choice.

The Novoferm Team

Contents

STEEL GARAGE DOORS

Steel up and over single doors	4-6
Steel up and over double doors	7-9
Novogaurd SBD doors	10
Steel matching side doors	11-12
Steel side hinged doors	13-15

INSULATED GARAGE DOORS

Duoport side hinged doors	16
---------------------------	----

SECTIONAL GARAGE DOORS

Sectional ISO 20	17-18
Sectional ISO 45 EVO	19-28
Specifications	29

ROLLER GARAGE DOORS

Novorol 77 door	30
Novorol 55 door	31

GRP GARAGE DOORS

GRP up and over single doors	36
GRP up and over double doors	37-38
GRP double side hinged doors	39

DOOR AUTOMATION

Operators	36-39
Accessories	40-43

TECHNICAL GUIDES AND INFORMATION

Technical Guides	44-61
Ordering sizes	62
Warranty information	63

Your Door, Our Passion...

STEEL UP & OVER GARAGE DOORS (FRAME INCLUDED)

Canopy or Retractable, frame included in price, with steel infill - manual operation.

Internal Frame Size Door Order Ref. (W x H)		VERTICAL		HORIZONTAL		VICTOR		HORSHAM*		REGENCY		GEORGIAN	
		C	R	C	R	C	R	C	R	C	R	C	R
Imperial	Metric												
7'0" x 6'6"	2134 x 1981	1133	1195	1133	1195	1396	1457	1396	1457	1442	1504	1442	1504
7'0" x 7'0"	2134 x 2134	1205	1267	1205	1267	1463	1524	1463	1524	1509	1571	1509	1571
7'0" x 7'6"	2134 x 2286	-	1380	-	1380	-	1581	-	1581	-	-	-	-
7'6" x 6'6"	2286 x 1981	1262	1324	1262	1324	1560	1622	1560	1622	1581	1643	1581	1643
7'6" x 7'0"	2286 x 2134	1396	1457	1396	1457	1694	1756	1694	1756	1705	1766	1705	1766
7'6" x 7'6"	2286 x 2286	-	1514	-	1514	-	1797	-	1797	-	-	-	-
8'0" x 6'6"	2438 x 1981	1421	1483	1421	1483	1803	1864	1803	1864	1900	1962	1900	1962
8'0" x 7'0"	2438 x 2134	1463	1524	1463	1524	1823	1885	1823	1885	1900	1962	1900	1962
8'0" x 7'6"	2438 x 2286	-	1638	-	1638	-	1936	-	1936	-	-	-	-
9'0" x 6'6"	2743 x 1981	-	1803	-	1803	-	1993	-	1993	-	2086	-	2086
9'0" x 7'0"	2743 x 2134	-	1957	-	1957	-	2117	-	2117	-	2204	-	2204
9'0" x 7'6"	2743 x 2286	-	2009	-	2009	-	2178	-	2178	-	-	-	2256

C = Canopy Gear, R = Retractable Gear

Size availability (mm) for Made to Measure doors (Internal frame size).

Fixing Frame Size - Canopy 54mm Legs 45mm Head. Retractable 70mm Legs 45mm Head

Minimum Width	1956	1981	1956	1981	1956	1981	1956	1981	1956	1981	1956	1981
Maximum Width	2438	2743	2438	2743	2438	2743	2438	2743	2438	2743	2438	2743
Minimum Height	1829	1860	1829	1860	1829	1860	1829	1860	1868	1868	1914	1914
Maximum Height	2134	2286	2134	2286	2134	2286	2134	2286	2134	2134	2134	2155

SPECIFICATION

Steel doors including windows

The standard window frame colour is white.

Colour matched window frames are available at no additional cost but must be specified at time of order.

Glazing Options

Berwick is supplied stippled as standard.

Black mock and clear glazing options are also available.

For made to measure pricing, please use next size up and add £200

For optional extras please see page 6.

● = Available in Rosewood

● = Available in Golden Oak

Ⓜ = Available as Glazed door

*Horsham Steel Up & Over is unavailable in Golden Oak & Rosewood in the following sizes:

9'0" x 6'6" (2743mm x 1981mm)

9'0" x 7'0" (2743mm x 2134mm)

9'0" x 7'6" (2743mm x 2286mm)

STEEL UP & OVER GARAGE DOORS (FRAME INCLUDED)

CONTINUED

Canopy or Retractable, frame included in price, with steel infill - manual operation.

Internal Frame Size Door Order Ref. (W x H)		MINSTER		BERKELEY VERTICAL		WENTWORTH		BERWICK		OPEN FOR INFIL	
		C	R	C	R	C	R	C	R	C	R
7'0" x 6'6"	2134 x 1981	1442	1504	1566	1627	1566	1627	1875	1936	989	-
7'0" x 7'0"	2134 x 2134	1509	1571	1633	1694	1633	1694	1911	1972	1030	-
7'0" x 7'6"	2134 x 2286	-	-	-	1751	-	1751	-	2009	-	-
7'6" x 6'6"	2286 x 1981	1581	1643	1730	1792	1730	1792	1967	2029	1071	-
7'6" x 7'0"	2286 x 2134	1705	1766	1864	1926	1864	1926	1988	2050	1112	-
7'6" x 7'6"	2286 x 2286	-	-	-	1967	-	1967	-	2086	-	-
8'0" x 6'6"	2438 x 1981	1900	1962	1972	2034	1972	2034	2050	2112	1133	-
8'0" x 7'0"	2438 x 2134	1900	1962	1993	2055	1993	2055	2070	2132	1174	-
8'0" x 7'6"	2438 x 2286	-	-	-	2106	-	2106	-	2163	-	-
9'0" x 6'6"	2743 x 1981	-	2086	-	2163	-	2163	-	-	-	-
9'0" x 7'0"	2743 x 2134	-	2204	-	2287	-	2287	-	-	-	-
9'0" x 7'6"	2743 x 2286	-	-	-	2348	-	2348	-	-	-	-

C = Canopy Gear, R = Retractable Gear

Size availability (mm) for Made to Measure doors (Internal frame size).



Fixing Frame Size - Canopy 54mm Legs 45mm Head. Retractable 70mm Legs 45mm Head

Minimum Width	1956	1981	1956	1981	1956	1981	1956	1981	1956	1981	1956	-
Maximum Width	2438	2743	2438	2743	2438	2743	2438	2743	2438	2591	2438	-
Minimum Height	1868	1868	1829	1860	1829	1860	1829	1860	1829	1860	1829	-
Maximum Height	2134	2134	2134	2286	2134	2286	2134	2286	2134	2286	2134	-

Open for infill have a maximum infill weight of 7kg/m2.

For optional extras please see page 6.

Horizontal ribbed doors over 2438mm wide will have a centre join profile.

-  = Available in Rosewood
-  = Available in Golden Oak
-  = Available as Glazed door

STEEL UP & OVER GARAGE DOORS CONTINUED

OPTIONAL EXTRAS

Single Steel Door Options

Powder coated door panel colours

Essential Colour (Black, White or Anthracite)	Incl. FOC
Standard Colour (See our 10 colours below)	£200
Elite Colour (See our 6 colours below)	£260
Signature Colour	POA
For Golden Oak & Rosewood	Add £500

Steel frame colour options

Essential colour (Black, White or Anthracite)	Incl. FOC
Standard or Elite colour (See our 16 colours below)	£145

*Colour-matched frames for Golden Oak - Clay Brown

*Colour-matched frames for Rosewood - Cherry Brown

Glazing options are available as follows:

Regency & Georgian - Stippled / Unleaded / Clear **£438**

Leading - Diamond Lattice / Queen Anne Lattice / Square Lattice **Add £438**

Berwick (Stippled as standard) or Clear Black Mock **Add £412**

Locking

4 Point Locking **£129**

Automated Options

Page 36

For made to measure pricing, please use next size up and add **£200**

Steel doors including windows

The standard window frame colour is white.

Colour matched window frames are available at no additional cost but must be specified at time of order.

Essential Colours

RAL 9016	Traffic White
RAL 9005	Jet Black
RAL 7016	Anthracite Grey

Standard Colours

RAL 5011	Midnight Blue
RAL 6005	Balmoral Green
BS4800	Chartwell Green
RAL 3003	Monarch Red
RAL 8017	Conker Brown
RAL 7004	Signal Grey
RAL 7038	Agate Grey
RAL 7035	Light Grey
RAL 7040	Window Grey
RAL 7030	Stone Grey

Elite Colours

RAL 8003	Clay Brown
RAL 5013	Oxford Blue
Chroma 3353	Cherry Brown
RAL 7015	Slate Grey
RAL 6009	Fir Green
RAL 9001	Cream

Signature Colours

We offer RAL colour options, that are not part of our Standard or Elite colour ranges. Price on application.

STEEL UP & OVER DOUBLE GARAGE DOORS (FRAME INCLUDED)

Retractable, frame included in price, with steel infill - manual operation.

Internal Frame Size Door Order Ref. (W x H)		VERTICAL	HORIZONTAL
		R	R
Imperial	Metric		
10'0" x 7'0"	3048 x 2134	2369	2369
10'0" x 7'6"	3048 x 2286	2421	2421
11'0" x 7'0"	3353 x 2134	2472	2472
11'0" x 7'6"	3353 x 2286	2524	2524
12'0" x 7'0"	3658 x 2134	2575	2575
12'0" x 7'6"	3658 x 2286	2627	2627
13'0" x 7'0"	3962 x 2134	2678	2678
13'0" x 7'6"	3962 x 2286	2730	2730
14'0" x 7'0"	4267 x 2134	2781	2781
14'0" x 7'6"	4267 x 2286	2833	2833
15'0" x 7'0"	4572 x 2134	2884	2884
15'0" x 7'6"	4572 x 2286	2936	2936
16'0" x 7'0"	4877 x 2134	2987	2987
16'0" x 7'6"	4877 x 2286	3039	3039

R = Retractable Gear

Size availability (mm) for Made to Measure doors (Internal frame size).

Fixing Frame Size - Retractable 68mm Legs 68mm Head

Minimum Width	2744	2744
Maximum Width	4877	4877
Minimum Height	1905	1905
Maximum Height	2286	2286



SPECIFICATION

Frames are supplied as standard in an essential colour. Colour matched frames are also available (please see the Optional Extras section).

The standard window frame colour is white.

Colour matched window frames are available at no extra cost but must be specified at time of order.

For optional extras, please see page 8.

-  = Available in Rosewood
-  = Available in Golden Oak
-  = Available as Glazed door

STEEL UP & OVER DOUBLE GARAGE DOORS (FRAME INCLUDED)

CONTINUED

Retractable, frame included in price, with steel infill - manual operation.

Internal Frame Size Door Order Ref. (W x H)		REGENCY		MINSTER		GEORGIAN	
		R		R		R	
Imperial	Metric	R		R		R	
10'0" x 7'0"	3048 x 2134	2575		2575		2575	
10'0" x 7'6"	3048 x 2286	-		-		-	
11'0" x 7'0"	3353 x 2134	2678		2678		2678	
11'0" x 7'6"	3353 x 2286	-		-		-	
12'0" x 7'0"	3658 x 2134	2781		2781		2781	
12'0" x 7'6"	3658 x 2286	-		-		-	
13'0" x 7'0"	3962 x 2134	2884		2884		2884	
13'0" x 7'6"	3962 x 2286	-		-		-	
14'0" x 7'0"	4267 x 2134	2987		2987		2987	
14'0" x 7'6"	4267 x 2286	-		-		-	
15'0" x 7'0"	4572 x 2134	-		3090		3090	
15'0" x 7'6"	4572 x 2286	-		-		-	
16'0" x 7'0"	4877 x 2134	-		3193		3193	
16'0" x 7'6"	4877 x 2286	-		-		-	

Size availability (mm) for Made to Measure doors (Internal frame size). Fixing Frame Size - Retractable 68mm Legs 68mm Head

Minimum Width	2744	2744	2744
Maximum Width	4877	4877	4877
Minimum Height	1905	1905	1930
Maximum Height	2134	2134	2155

OPTIONAL EXTRAS

Double Steel Door Options

Powder coated door colours

Essential Colour (Black, White or Anthracite)	Incl. FOC
Standard Colour (See our 10 colours on page 9)	£355
Elite Colour (See our 6 colours page 9)	£450
Signature Colour	POA
For Golden Oak & Rosewood	Add £850

Steel frame colour options

Essential colour (Black, White or Anthracite)	Incl. FOC
Standard or Elite colour (See our 16 colours on Page 9)	£160

*Colour-matched frames for Golden Oak - Clay Brown

*Colour-matched frames for Rosewood - Cherry Brown

● = Available in Rosewood ● = Available in Golden Oak

G = Available as Glazed door

Extended 3-point locking as standard

Glazing options are available as follows:

Regency & Georgian - Stippled / Unleaded / Clear	£876
Leading - Diamond Lattice / Queen Anne Lattice / Square Lattice	Add £876
Berwick (Stippled as standard) or Clear	
Black Mock	£824

Automated Options



Page 36

For made to measure pricing, please use next size up and add £200.

STEEL UP & OVER DOUBLE GARAGE DOORS (FRAME INCLUDED)

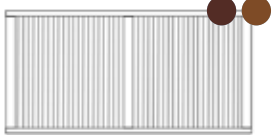
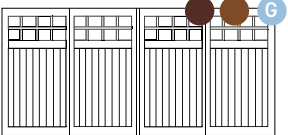
CONTINUED

Internal Frame Size Door Order Ref. (W x H)		BERKELEY VERTICAL 	BERWICK 
Imperial	Metric	R	R
10'0" x 7'0"	3048 x 2134	2678	3090
10'0" x 7'6"	3048 x 2286	2730	-
11'0" x 7'0"	3353 x 2134	2781	3193
11'0" x 7'6"	3353 x 2286	2833	-
12'0" x 7'0"	3658 x 2134	2884	3296
12'0" x 7'6"	3658 x 2286	2936	-
13'0" x 7'0"	3962 x 2134	2987	3347
13'0" x 7'6"	3962 x 2286	3039	-
14'0" x 7'0"	4267 x 2134	3090	3399
14'0" x 7'6"	4267 x 2286	3142	-
15'0" x 7'0"	4572 x 2134	3193	-
15'0" x 7'6"	4572 x 2286	3245	-
16'0" x 7'0"	4877 x 2134	3296	-
16'0" x 7'6"	4877 x 2286	3348	-

-  = Available in Rosewood
-  = Available in Golden Oak
-  = Available as Glazed door

Berwick doors come with stippled glazing as standard. Berwick doors become 3 windows configuration under 12' 6" wide (3810mm).

Size availability (mm) for Made to Measure doors (Internal frame size).

Fixing Frame Size - Retractable 68mm Legs 68mm Head

Minimum Width	2744	3048
Maximum Width	4877	4267
Minimum Height	1905	1905
Maximum Height	2286	2134

Essential Colours

- RAL 9016 Traffic White
- RAL 9005 Jet Black
- RAL 7016 Anthracite Grey

Standard Colours

- RAL 5011 Midnight Blue
- RAL 6005 Balmoral Green
- BS4800 Chartwell Green
- RAL 3003 Monarch Red
- RAL 8017 Conker Brown
- RAL 7004 Signal Grey
- RAL 7038 Agate Grey
- RAL 7035 Light Grey
- RAL 7040 Window Grey
- RAL 7030 Stone Grey

Elite Colours

- RAL 8003 Clay Brown
- RAL 5013 Oxford Blue
- Chroma 3353 Cherry Brown
- RAL 7015 Slate Grey
- RAL 6009 Fir Green
- RAL 9001 Cream

Signature Colour

We offer RAL colour options, that are not part of our Standard or Elite colour ranges. Price on application.

NOVOGUARD SECURED BY DESIGN STEEL UP & OVER GARAGE DOORS (FRAME INCLUDED)



Novoferm Secured by Design doors are certificated to CS5051 STS202 which is approved by ACPD, Association Of Chief Police Officers

Retractable, pre-framed, with steel infill - manual operation.

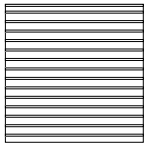
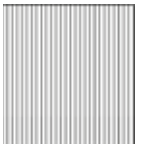
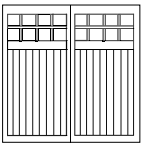
Internal Frame Size Door Order Ref. (W x H)		HORIZONTAL 	VERTICAL 	BERWICK 
Imperial	Metric	R	R	R
7'0" x 6'6"	2134 x 1981	1545	1669	2364
7'0" x 7'0"	2134 x 2134	1669	1710	2379
7'0" x 7'6"	2134 x 2286	1875	1906	2441
7'6" x 6'6"	2286 x 1981	1736	1803	2426
7'6" x 7'0"	2286 x 2134	1875	1906	2441
7'6" x 7'6"	2286 x 2286	2014	2045	2575
8'0" x 6'6"	2438 x 1981	2153	2009	2529
8'0" x 7'0"	2438 x 2134	2153	2009	2529
8'0" x 7'6"	2438 x 2286	2318	2168	2693

Minimum height of a single retractable door is 1880mm.

**Fixing Frame Size - Retractable
70mm Legs 45mm Head**

**For made to measure pricing,
please use next size up and add
£200.**

SPECIFICATION

Novoferm Secured by Design (SBD) garage doors can only be supplied with a 70mm wide factory fitted steel fixing frame and 45mm frame head as standard. **Secured by Design doors are bespoke and made to order. Automation is not available with Secured By Design doors.**

OPTIONAL EXTRAS

Powder coated door panel colours

Essential Colour (Black, White or Anthracite)	Incl. FOC
Standard Colour (See our 10 colours)	£200
Elite Colour (See our 6 colours)	£260
Signature Colour	POA

Steel frame colour options

Essential colour (Black, White or Anthracite)	Incl. FOC
Standard or Elite colour (See our 10 colours)	£145

The standard window frame colour for a Berwick is white.

Colour matched window frames are available at no extra cost but must be specified at time of order.

Essential Colours

RAL 9016	Traffic White
RAL 9005	Jet Black
RAL 7016	Anthracite Grey

Standard Colours

RAL 5011	Midnight Blue
RAL 6005	Balmoral Green
BS4800	Chartwell Green
RAL 3003	Monarch Red
RAL 8017	Conker Brown
RAL 7004	Signal Grey
RAL 7038	Agate Grey
RAL 7035	Light Grey
RAL 7040	Window Grey
RAL 7030	Stone Grey

Elite Colours

RAL 8003	Clay Brown
RAL 5013	Oxford Blue
Chroma 3353	Cherry Brown
RAL 7015	Slate Grey
RAL 6009	Fir Green
RAL 9001	Cream

Signature

We offer RAL colour options, that are not part of our Standard or Elite colour ranges. Price on application.

STEEL MATCHING SIDE DOORS (FRAME INCLUDED)

Single hinged, internal frame sizes, with steel infill - doors are supplied with a frame.

Internal Frame Size Door Order Ref. (W x H)		Overall frame size	VERTICAL	HORIZONTAL	OPEN FOR INFIL
Imperial	Metric				
2'10" x 6'2"	875 x 1875	975 x 1925	1051	1051	999
2'10" x 6'6"	875 x 1981	975 x 2031	1061	1061	1061
2'10" x 7'0"	875 x 2134	975 x 2184	1076	1076	1076
2'10" x 7'6"	875 x 2286	975 x 2336	1092	1092	1092
3'3" x 6'6"	1000 x 1981	1100 x 2031	1102	1102	1102
3'3" x 7'0"	1000 x 2134	1100 x 2184	1112	1112	1112
3'3" x 7'6"	1000 x 2286	1100 x 2336	1138	1138	1138

SPECIFICATION

Open for infill have a maximum infill weight of 7kg/m².

Size availability (mm) for Made to Measure doors (Internal frame size)

Fixing Frame Size - 50mm Legs 50mm Head

Minimum Width	689	689	689
Maximum Width	1219	1219	1219
Minimum Height	1775	1775	1775
Maximum Height	2286	2286	2286

- = Available in Rosewood
- = Available in Golden Oak
- G = Available as Glazed door

OPTIONAL EXTRAS

Steel Side Door Options

Powder coated door panel colours

Essential Colour (Black, White or Anthracite)	Incl. FOC
Standard Colour (See our 10 colours on page 12)	£200
Elite Colour (See our 6 colours page 12)	£260
Signature Colour	POA
For Golden Oak & Rosewood	Add £300

Steel frame colour options

Essential colour (Black, White, Anthracite)	Incl. FOC
Standard or Elite colour (See our 16 colours on page 12)	£145

*Colour-matched frames for Golden Oak - Clay Brown

*Colour-matched frames for Rosewood - Cherry Brown

Glazing options are available as follows:

Regency	£176
Door stays	Add £83

Steel doors including windows

The standard window frame colour is white.

Colour matched window frames are available but must be specified at time of order.

Steel Matching Side Doors are available as inward and outward opening.

Inward Opening £62

Thumb Turn Cylinder Lock £52

Only available in brushed silver to match the handle. If ordering a black handle, the thumb turn will remain brushed silver - only the escutcheon will match the black handle.

STEEL MATCHING SIDE DOORS (FRAME INCLUDED)

CONTINUED

Single hinged, internal frame sizes, with steel infill - doors are supplied with a frame.

Internal Frame Size Order Ref. (W x H)		Overall Frame size	REGENCY	GEORGIAN	VICTOR	HORSHAM
Imperial	Metric					
2'10" x 6'2"	875 x 1875	975 x 1925	1133	1133	1133	1133
2'10" x 6'6"	875 x 1981	975 x 2031	1205	1205	1205	1205
2'10" x 7'0"	875 x 2134	975 x 2184	1221	1221	1221	1221
2'10" x 7'6"	875 x 2286	975 x 2336	1246	1246	1246	1246
3'3" x 6'6"	1000 x 1981	1100 x 2031	1267	1267	1267	1267
3'3" x 7'0"	1000 x 2134	1100 x 2184	1324	1324	1324	1324
3'3" x 7'6"	1000 x 2286	1100 x 2336	-	1396	1396	1396

Size availability (mm) for Made to Measure doors (Internal frame size).

Fixing Frame Size - 50mm Legs 50mm Head

	REGENCY	GEORGIAN	VICTOR	HORSHAM
Min Width	689	689	689	689
Max Width	1219	1219	1219	1219
Min Height	1868	1912	1775	1775
Max Height	2134	2155	2286	2286

Internal Frame Size Door Order Ref. (W x H)		Overall Frame size	BERKELEY VERTICAL
Imperial	Metric		
2'10" x 6'2"	875 x 1875	975 x 1925	1391
2'10" x 6'6"	875 x 1981	975 x 2031	1442
2'10" x 7'0"	875 x 2134	975 x 2184	1457
2'10" x 7'6"	875 x 2286	975 x 2336	1473
3'3" x 6'6"	1000 x 1981	1100 x 2031	1488
3'3" x 7'0"	1000 x 2134	1100 x 2184	1504
3'3" x 7'6"	1000 x 2286	1100 x 2336	1519

Size availability (mm) for Made to Measure doors (Internal frame size)

Fixing Frame Size - 50mm Legs 50mm Head

	BERKELEY VERTICAL
Minimum Width	689
Maximum Width	1219
Minimum Height	1775
Maximum Height	2286

- = Available in Rosewood
- = Available in Golden Oak
- G = Available as Glazed door

Essential Colours

RAL 9016	Traffic White
RAL 9005	Jet Black
RAL 7016	Anthracite Grey

Standard Colours

RAL 5011	Midnight Blue
RAL 6005	Balmoral Green
BS4800	Chartwell Green
RAL 3003	Monarch Red
RAL 8017	Conker Brown
RAL 7004	Signal Grey
RAL 7038	Agate Grey
RAL 7035	Light Grey
RAL 7040	Window Grey
RAL 7030	Stone Grey

Elite Colours

RAL 8003	Clay Brown
RAL 5013	Oxford Blue
Chroma 3353	Cherry Brown
RAL 7015	Slate Grey
RAL 6009	Fir Green
RAL 9001	Cream

Signature

We offer RAL colour options, that are not part of our Standard or Elite colour ranges. Price on application.

STEEL DOUBLE SIDE HINGED GARAGE DOORS (FRAME INCLUDED)

Double side hinged, internal frame sizes, with steel infill - frame included in price.

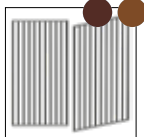
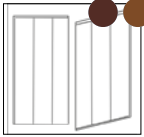
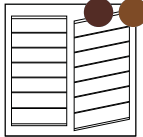
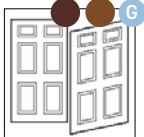
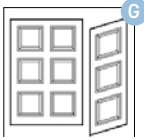
Internal Frame Size Door Order Ref. (W x H)		Overall Frame Size	VERTICAL	VICTOR	HORSHAM	REGENCY	GEORGIAN
Imperial	Metric						
			($\frac{2}{3}$ - $\frac{1}{3}$ / $\frac{1}{2}$ - $\frac{1}{2}$)	($\frac{1}{2}$ - $\frac{1}{2}$)	($\frac{1}{2}$ - $\frac{1}{2}$)	($\frac{1}{2}$ - $\frac{1}{2}$)	($\frac{2}{3}$ - $\frac{1}{3}$)
7'0" x 7'0"	2134 x 2134	2234 x 2184	1995	2100	2100	2399	2100
7'0" x 7'6"	2134 x 2286	2234 x 2336	2048	2153	2153	-	-
7'6" x 7'0"	2286 x 2134	2386 x 2184	2100	2205	2205	2494	2258
7'6" x 7'6"	2286 x 2286	2386 x 2336	2153	2258	2258	-	-
8'0" x 7'0"	2438 x 2134	2538 x 2184	2205	2310	2310	2583	2389
8'0" x 7'6"	2438 x 2286	2538 x 2336	2258	2363	2363	-	-

Size availability (mm) for Made to Measure doors (Internal frame size).

Fixing Frame Size - 50mm Legs 50mm Head

	VERTICAL	VICTOR	HORSHAM	REGENCY	GEORGIAN
Minimum Width	1750	1750	1750	1839	1998
Maximum Width	2438	2438	2438	2438	2438
Minimum Height	1775	1775	1775	1868	1912
Maximum Height	2286	2286	2286	2134	2155

Essential Colours

RAL 9016	Traffic White
RAL 9005	Jet Black
RAL 7016	Anthracite Grey

Standard Colours



RAL 5011	Midnight Blue
RAL 6005	Balmoral Green
BS4800	Chartwell Green
RAL 3003	Monarch Red
RAL 8017	Conker Brown
RAL 7004	Signal Grey
RAL 7038	Agate Grey
RAL 7035	Light Grey
RAL 7040	Window Grey
RAL 7030	Stone Grey

Elite Colours

RAL 8003	Clay Brown
RAL 5013	Oxford Blue
Chroma 3353	Cherry Brown
RAL 7015	Slate Grey
RAL 6009	Fir Green
RAL 9001	Cream

Signature

We offer RAL colour options, that are not part of our Standard or Elite colour ranges. Price on application.

-  = Available in Rosewood
-  = Available in Golden Oak
-  = Available as Glazed door

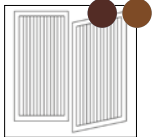
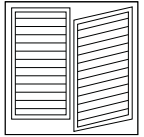
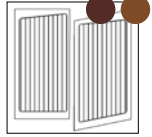
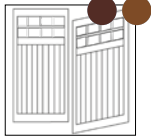

STEEL DOUBLE SIDE HINGED GARAGE DOORS (FRAME INCLUDED)

Internal Frame Size Door Order Ref. (W x H)		Overall Frame Size	BERKELEY VERTICAL	BERKELEY HORIZONTAL	WENTWORTH	BERWICK
Imperial	Metric		 (1/2 - 1/2)	 (1/2 - 1/2)	 (1/2 - 1/2)	 (1/2 - 1/2)
7'0" x 7'0"	2134 x 2134	2234 x 2184	2415	2415	2415	2520
7'0" x 7'6"	2134 x 2286	2234 x 2336	2520	2520	2520	2625
7'6" x 7'0"	2286 x 2134	2386 x 2184	2625	2625	2625	2730
7'6" x 7'6"	2286 x 2286	2386 x 2336	2730	2730	2730	2835
8'0" x 7'0"	2438 x 2134	2538 x 2184	2835	2835	2835	2940
8'0" x 7'6"	2438 x 2286	2538 x 2336	2940	2940	2940	3045

Size availability (mm) for Made to Measure doors (Internal frame size).

Fixing Frame Size - 50mm Legs 50mm Head

Minimum Width	1750	1750	1750	2083
Maximum Width	2438	2438	2438	2438
Minimum Height	1775	1775	1775	1775
Maximum Height	2286	2286	2286	2286

-  = Available in Rosewood
-  = Available in Golden Oak

SPECIFICATION

Door hinges can come in black or white only.

Handle options at time of ordering include black or brushed silver - please specify on order.

Brushed silver handles are chargeable unless requested on the original order POA.

The large leaf can be the lead door. Please see the opening options (viewed from outside) below:

A 2/3-1/3 Left Hand Opening

C 2/3-1/3 Right Hand Opening

B 1/3-2/3 Left Hand Opening

D 1/3-2/3 Right Hand Opening

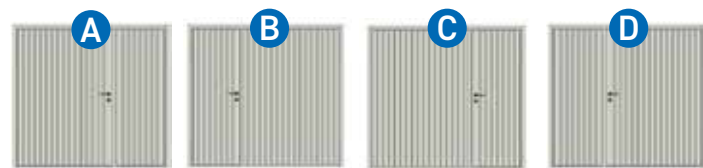

Essential Colours

RAL 9016	Traffic White
RAL 9005	Jet Black
RAL 7016	Anthracite Grey

Standard Colours

RAL 5011	Midnight Blue
RAL 6005	Balmoral Green
BS4800	Chartwell Green
RAL 3003	Monarch Red
RAL 8017	Conker Brown
RAL 7004	Signal Grey
RAL 7038	Agate Grey
RAL 7035	Light Grey
RAL 7040	Window Grey
RAL 7030	Stone Grey

Elite Colours

RAL 8003	Clay Brown
RAL 5013	Oxford Blue
Chroma 3353	Cherry Brown
RAL 7015	Slate Grey
RAL 6009	Fir Green
RAL 9001	Cream

Signature

We offer RAL colour options, that are not part of our Standard or Elite colour ranges. Price on application.

STEEL DOUBLE SIDE HINGED GARAGE DOORS (FRAME INCLUDED)

CONTINUED

OPTIONAL EXTRAS

Steel Double Side Hinged Door Options

Powder coated door panel colours

Essential colour (Black, White or Anthracite)	FOC
Standard colour (See our 10 colours on page 14)	£245
Elite colour (See our 6 colours on page 14)	£325
Signature Colour	POA
For Golden Oak & Rosewood	Add £500

Steel frame colour options

Essential colour (Black, White, Anthracite)	Incl. FOC
Standard or Elite colour (See our 16 colours on page 14)	£145

***Colour-matched frames for Golden Oak - Clay Brown**

***Colour-matched frames for Rosewood - Cherry Brown**

Glazing options are available as follows:

Regency & Georgian - Stippled / Unleaded / Clear	£438
Leading - Diamond Lattice / Queen Anne Lattice / Square Lattice	Add £438

Berwick (Stippled as standard) or Clear Black Mock	£412
-------------------------------------------------------	-------------

Steel doors including windows

The standard window frame colour is white.

Colour matched window frames are available at no extra cost but must be specified at time of order.

Thumb Turn Cylinder Lock **£52**

Only available in brushed silver to match the handle. If ordering black handle, thumb-turn will remain brushed silver - only the escutcheon will match the black handle.

Steel Side Hinged doors are available with inward and outward opening.

Inward Opening **£103**

All side hinged doors come complete with door stays.

For made to measure pricing, please use next size up.

DUOPORT 45MM INSULATED DOUBLE SIDE HINGED GARAGE DOORS ALUMINIUM FRAME WITH A THERMAL BREAK

DUOPORT HORIZONTAL RIB WOODGRAIN



Horizontal Rib

Overall Frame Size (up to)		White RAL 9016	Super Colour	RAL
Width	Height			
2580	2165	3754	4130	4594
2580	2540	3940	4378	4923

DUOPORT LARGE RIB WOODGRAIN OR SMOOTH



Large Rib

Overall Frame Size (up to)		Woodgrain White RAL 9016	Woodgrain Super Colour	Woodgrain RAL	Smooth White RAL 9016	Smooth Super Colour	Smooth RAL	Satin White, Grey, Brown, Dark Grey	Dark Oak Winchester Night Oak
Width	Height								
2580	2165	3754	4130	4594	4027	4403	4867	4027	4419
2580	2540	3940	4378	4923	4238	4676	5217	4238	4650

DUOPORT FLUSH WOODGRAIN OR SMOOTH



Flush

Overall Frame Size (up to)		Woodgrain White RAL 9016	Woodgrain Super Colour	Woodgrain RAL	Smooth White RAL 9016	Smooth Super Colour	Smooth RAL	Satin White, Grey, Brown, Dark Grey	Dark Oak Winchester Night Oak
Width	Height								
2580	2165	5088	5459	5923	5413	5783	6247	5413	5979
2580	2540	5351	5789	6335	5737	6180	6721	5737	6293

DUOPORT PANELLED WOODGRAIN



Panelled

Overall Frame Size (up to)		Woodgrain White RAL 9016	Woodgrain Super Colour	Woodgrain RAL colour	Dark Oak Winchester Night Oak
Width	Height				
2580	2165	5279	5655	6159	6051

Minimum Frame Size for all Duoport doors - 1530w x 1940h

Fixing Frame Size - 40mm Legs 40 mm Head

Please state opening direction and handing of active leaf when ordering 50/50 split.

Asymmetrical split available.

OPTIONAL EXTRAS

Thermally Separated Frame - Type H

add £1128 per door

3 Point Locking

add £433 per door

Door Closer and hold open device

add £505 per leaf

Handles

Stainless Steel

add £145 each

Silver

add £145 each

White

add £165 each

Windows

V1

add £145 each

V2

add £145 each

V3

add £145 each

V8

add £510 each

V9

add £485 each

Light Strip Clear

add £155 per leaf

Light Strip Crystal

add £165 per leaf

Ventilation

add £83 per leaf

SECTIONAL ISO 20 OVERHEAD GARAGE DOORS

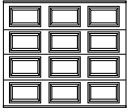

Panelled



Horizontal Large Rib

ISO 20 PANELLED WOODGRAIN

	Width	2250	2375	2500	2750	3000
Height	Max windows	3	4	4	4	5
1875	White & Anthracite	1648	1705	1761	1998	2014
	Super Colour	1823	1885	1942	2235	2251
	RAL Colour	1998	2060	2117	2467	2482
2000 2125	White & Anthracite	1648	1705	1761	1998	2014
	Super Colour	1823	1885	1942	2235	2251
	RAL Colour	1998	2060	2117	2467	2482
2250	White & Anthracite	1756	1772	1787	2132	2359
	Super Colour	1931	1947	1962	2369	2596
	RAL Colour	2106	2127	2137	2601	2827
2375 2500	White & Anthracite	1839	1849	1859	2148	2436
	Super Colour	2014	2029	2039	2384	2673
	RAL Colour	2189	2204	2215	2616	2905
2625 2750	White & Anthracite	2178	2199	2220	2498	2776
	Super Colour	2359	2374	2395	2735	3013
	RAL Colour	2534	2549	2570	2966	3245

For Fixing Frame Sizes, please view pages 54 - 58.

ISO 20 Sectional doors

up to 2125mm 4 panels high
up to 2500mm 5 panels high
up to 3000mm 6 panels high

For made to measure pricing, use the next size up.

*For made to measure heights, panel heights may vary.
Please contact before ordering.

For Optional Extras, see page 18.

Please note: Number of windows are provided as a guide based on door width - please check when ordering for actual number of windows.

ISO 20 HORIZONTAL AND LARGE RIB WOODGRAIN

	Width	2250	2375	2500	2750	3000
Height	Max windows	3	4	4	4	5
1875	White & Anthracite	1370	1406	1442	1530	1612
	Super Colour	1545	1581	1622	1761	1849
	RAL Colour	1720	1761	1797	1993	2081
2000 2125	White & Anthracite	1370	1406	1442	1530	1612
	Super Colour	1545	1581	1622	1761	1849
	RAL Colour	1720	1761	1797	1993	2081
2250	White & Anthracite	1437	1447	1457	1617	1772
	Super Colour	1617	1622	1633	1854	2009
	RAL Colour	1792	1803	1808	2086	2240
2375 2500	White & Anthracite	1488	1504	1514	1741	1967
	Super Colour	1669	1679	1689	1978	2204
	RAL Colour	1844	1854	1864	2209	2436
2625 2750	White & Anthracite	1761	1777	1787	1983	2178
	Super Colour	1942	1952	1962	2220	2415
	RAL Colour	2117	2132	2137	2457	2647

Minimum Width	2000
Maximum Width	2950

SECTIONAL ISO 20 OVERHEAD GARAGE DOORS

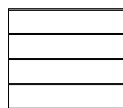

Flush

ISO 20 FLUSH SMOOTH

	Width	2250	2375	2500	2750	3000
Height	Max windows	3	4	4	4	5
1875	White & Anthracite	1715	1777	1833	2009	2178
	Super Colour	1895	1952	2009	2240	2415
	RAL Colour	2070	2132	2184	2477	2647
2000 2125	White & Anthracite	1715	1777	1833	2009	2178
	Super Colour	1895	1952	2009	2240	2415
	RAL Colour	2070	2132	2184	2477	2647
2250	White & Anthracite	1808	1833	1854	2065	2271
	Super Colour	1988	2009	2034	2302	2508
	RAL Colour	2163	2184	2209	2534	2740
2375 2500	White & Anthracite	1854	1869	1880	2153	2426
	Super Colour	2034	2045	2055	2390	2663
	RAL Colour	2209	2225	2230	2621	2894
2625 2750	White & Anthracite	2112	2122	2132	2395	2652
	Super Colour	2348	2359	2369	2632	2889
	RAL Colour	2580	2596	2601	2863	3121

Size availability (mm) for Made to Measure doors (Internal frame size).

For Fixing Frame Sizes, please view pages 54 - 58.

Minimum Width	2000
Maximum Width	2950

ISO 20 Sectional doors

up to 2125mm 4 panels high
up to 2500mm 5 panels high
up to 3000mm 6 panels high

For made to measure pricing, use the next size up.

*For made to measure heights, panel heights may vary. Please contact before ordering.

Please note: Number of windows are provided as a guide based on door width - please check when ordering for actual number of windows.

OPTIONAL EXTRAS

Sectional frame heads are colour matched to the door as standard.

Frame leg cover profiles 2.5m length

White / Anthracite	85mm x 20mm (per pair)	£124
	55mm x 20mm (per pair)	£124
Super Colour	85mm x 20mm (per pair)	£134
	55mm x 20mm (per pair)	£134
RAL colour	85mm x 20mm (per pair)	£206
	55mm x 20mm (per pair)	£206

Super Colour Options

Stone Grey RAL 7030, Moss Green RAL 6005, Fir Green RAL 6009, Light Grey RAL 7035, Window Grey RAL 7040, White Aluminium RAL 9006, Quartz Grey RAL 7039, Basalt Grey 7012, Grey Aluminium RAL 9007, Slate Grey RAL 7015, Nut Brown RAL 8011, Sepia Brown RAL 8014, Dark Grey DB 703, Black RAL 9005

Handle options

Manual locking with Black D Handle	£109
Metal 'D' handles (White, Black)	£206

Automated Options

From page 36

Sectional doors are bespoke and made to order.

Glazing Options (for styles see page 29)

Window option clear/crystal, V1, V2, V3 (per window)	White frame £176
	Super Colour or RAL frame £201

Window option clear/crystal, V4d, V4s (per window)	White frame £191
	Super Colour or RAL frame £206

V8 windows not available

SECTIONAL ISO 45 EVO OVERHEAD GARAGE DOORS

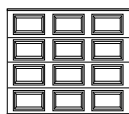

Panelled

ISO 45 EVO PANELLED WOODGRAIN

	Width	2250	2375	2500	2750	3000	3250	3500	3750	4000	4250	4500	4750	5000	5250	5500
Height	No. of windows	3	3	3	4	4	4	4	4	5	5	6	6	6	6	7
1875 2000 2125	White & Anthracite	1828	1895	1957	2220	2235	2755	2936	3090	3167	3245	3399	3554	3595	-	-
	Super Colour	2024	2091	2153	2482	2498	3018	3198	3353	3492	3569	3857	4012	4053	-	-
	RAL Colour	2220	2287	2348	2740	2755	3275	3456	3610	3816	3893	4311	4465	4506	-	-
2250	White & Anthracite	1947	1967	1983	2369	2621	2874	2987	3116	3203	3286	3430	3574	3631	-	-
	Super Colour	2142	2163	2178	2632	2884	3131	3250	3378	3528	3610	3888	4032	4089	-	-
	RAL Colour	2338	2359	2374	2889	3142	3394	3507	3636	3852	3935	4341	4486	4542	-	-
2375 2500	White & Anthracite	2039	2055	2065	2384	2704	3023	3342	3662	3765	3868	3971	4074	4177	-	-
	Super Colour	2235	2251	2261	2647	2966	3286	3605	3924	4089	4192	4429	4532	4635	-	-
	RAL Colour	2431	2446	2457	2905	3224	3543	3863	4182	4414	4517	4882	4985	5088	-	-
2625 2750	White & Anthracite	2421	2441	2462	2771	3080	3389	3698	4012	4156	4300	4450	4594	4738	-	-
	Super Colour	2616	2637	2657	3033	3342	3651	3960	4269	4481	4625	4903	5047	5196	-	-
	RAL Colour	2812	2833	2853	3291	3600	3909	4218	4527	4805	4949	5356	5505	5650	-	-
2875	White & Anthracite	2683	2863	3044	3224	3404	3584	3765	3945	4125	4305	4486	4661	4841	-	-
	Super Colour	2879	3059	3239	3487	3667	3842	4022	4202	4450	4630	4939	5119	5299	-	-
	RAL Colour	3075	3255	3435	3744	3924	4105	4285	4465	4774	4954	5392	5572	5753	-	-
3000 3125	White & Anthracite	3646	3754	3863	3971	4079	4187	4295	4403	4511	4620	4728	4836	4944	-	-
	Super Colour	3842	3950	4058	4233	4341	4450	4558	4666	4836	4944	5186	5294	5402	-	-
	RAL Colour	4038	4146	4254	4362	4470	4578	4687	4795	5160	5268	5639	5747	5856	-	-

For Fixing Frame Sizes, please view pages 54 - 58.

ISO 45 EVO Sectional doors

up to 2125mm 4 panels high
up to 2500mm 5 panels high
up to 3000mm 6 panels high

For made to measure pricing, use the next size up.

*For made to measure heights, panel heights may vary. Please contact before ordering.

For Optional Extras, see page 24.

Please note: Number of windows are provided as a guide based on door width - please check when ordering for actual number of windows.

ISO 45 EVO Panelled Woodgrain

Min Width	2000
Max Width	5000
Min Height	1800
Max Height	3125

SECTIONAL ISO 45 EVO OVERHEAD GARAGE DOORS CONTINUED

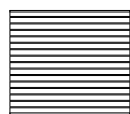

Horizontal Rib

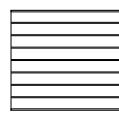

Large Rib



Flush

ISO 45 EVO HORIZONTAL, LARGE RIB AND FLUSH WOODGRAIN

	Width	2250	2375	2500	2750	3000	3250	3500	3750	4000	4250	4500	4750	5000	5250	5500
Height	No. of windows	3	3	3	4	4	4	4	4	5	5	6	6	6	6	7
1875 2000 2125	White & Anthracite	1519	1560	1602	1694	1787	2045	2287	2421	2472	2524	2647	2766	2781	2874	2961
	Super Colour	1715	1756	1797	1957	2050	2307	2549	2683	2796	2848	3100	3224	3239	3327	3481
	RAL Colour	1911	1952	1993	2215	2307	2565	2807	2941	3121	3172	3554	3677	3693	3780	4002
2250	White & Anthracite	1597	1607	1617	1792	1967	2142	2318	2472	2524	2575	2693	2807	2833	2925	3013
	Super Colour	1792	1803	1813	2055	2230	2405	2580	2735	2848	2899	3147	3265	3291	3378	3533
	RAL Colour	1988	1998	2009	2312	2487	2663	2838	2992	3172	3224	3600	3718	3744	3832	4053
2375 2500	White & Anthracite	1653	1669	1679	1931	2184	2436	2688	2941	2997	3059	3116	3172	3229	3466	3703
	Super Colour	1849	1864	1875	2194	2446	2699	2951	3203	3327	3384	3569	3626	3682	3919	4223
	RAL Colour	2045	2060	2070	2451	2704	2956	3208	3461	3651	3708	4022	4079	4135	4378	4743
2625 2750	White & Anthracite	1957	1972	1983	2204	2421	2642	2858	3075	3172	3265	3358	3456	3548	3754	3955
	Super Colour	2153	2168	2178	2462	2683	2899	3116	3337	3497	3590	3816	3909	4002	4208	4475
	RAL Colour	2348	2364	2374	2724	2941	3157	3378	3595	3821	3914	4269	4362	4460	4661	4996
2875	White & Anthracite	2168	2307	2446	2580	2719	2858	2997	3131	3270	3409	3543	3682	3821	3955	-
	Super Colour	2364	2503	2642	2843	2982	3116	3255	3394	3595	3734	4002	4135	4275	4414	-
	RAL Colour	2560	2699	2833	3100	3239	3378	3512	3651	3919	4058	4455	4594	4728	4867	-
3000 3125	White & Anthracite	2611	2724	2838	2951	3064	3178	3286	3399	3512	3626	3739	3852	3966	4074	-
	Super Colour	2807	2920	3033	3208	3322	3435	3548	3662	3837	3950	4192	4305	4419	4532	-
	RAL Colour	3002	3116	3229	3471	3584	3698	3806	3919	4161	4275	4645	4759	4872	4985	-

For Fixing Frame Sizes, please view pages 54 - 58.

For made to measure pricing, use the next size up.

Heights between 2125mm and 2225mm have cut top panels.

*For made to measure heights, panel heights may vary. Please contact before ordering.

For Optional Extras, see page 24.

Please note: Number of windows are provided as a guide based on door width - please check when ordering for actual number of windows.

SECTIONAL ISO 45 EVO OVERHEAD GARAGE DOORS CONTINUED

ISO 45 EVO LARGE RIB SMOOTH

Available in these Wood Effects finishes: Golden Oak, Dark Oak, Winchester, Night Oak

Available in these Satin finishes: Satin Black, Satin White, Satin Window Grey, Satin Dark Grey, Satin Brown, Satin Grey

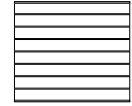

Large Rib

	Width	2250	2375	2500	2750	3000	3250	3500	3750	4000	4250	4500	4750	5000	5250	5500
Height	No. of windows	3	3	3	4	4	4	4	4	5	5	6	6	6	6	7
1875 2000 2125	White & Anthracite	1751	1803	1854	2009	2163	2652	2833	2961	3039	3116	3208	3296	3425	3502	3579
	Super Colour	1947	1998	2050	2204	2359	2848	3028	3157	3363	3440	3662	3754	3883	3960	4038
	RAL Colour	2142	2194	2245	2400	2554	3044	3224	3353	3687	3765	4115	4208	4336	4414	4491
	Wood Effects	1895	1916	1926	2096	2251	2750	2925	3069	3142	3224	3311	3404	3533	3620	3693
	Satin	1880	1906	1936	2050	2204	2699	2879	3013	3090	3167	3260	3358	3487	3564	3641
2250	White & Anthracite	1890	1911	1931	2163	2395	2627	2858	2987	3080	3167	3260	3348	3502	3579	3657
	Super Colour	2086	2106	2127	2359	2590	2822	3054	3183	3404	3492	3713	3806	3960	4038	4115
	RAL Colour	2281	2302	2323	2554	2786	3018	3250	3378	3729	3816	4166	4259	4414	4491	4568
	Wood Effects	1998	2014	2034	2292	2518	2760	2987	3131	3219	3311	3399	3497	3651	3744	3816
	Satin	1926	1947	1967	2204	2436	2673	2905	3039	3131	3224	3311	3409	3564	3646	3723
2375 2500	White & Anthracite	2034	2060	2081	2374	2663	2951	3239	3528	3687	3847	4007	4166	4032	4182	4326
	Super Colour	2230	2251	2276	2565	2858	3147	3435	3723	4012	4172	4465	4625	4486	4635	4784
	RAL Colour	2421	2446	2472	2760	3049	3342	3631	3919	4336	4496	4918	5078	4944	5088	5238
	Wood Effects	2106	2127	2153	2462	2745	3075	3358	3667	3816	3976	4130	4295	4161	4326	4465
	Satin	2070	2096	2122	2415	2709	3008	3296	3595	3754	3914	4074	4238	4105	4259	4408
2625 2750	White & Anthracite	2477	2503	2534	2673	2936	3198	3461	3723	3873	4017	4161	-	-	-	-
	Super Colour	2673	2699	2730	2936	3198	3461	3723	3986	4197	4341	4620	-	-	-	-
	RAL Colour	2869	2894	2925	3193	3456	3718	3981	4244	4522	4666	5073	-	-	-	-
	Wood Effects	2570	2596	2627	2766	3023	3322	3579	3863	4002	4146	4285	-	-	-	-
	Satin	2524	2549	2580	2719	2987	3260	3523	3790	3940	4089	4233	-	-	-	-
2875	White & Anthracite	2590	2755	2915	3075	3239	3399	3559	3723	3883	4043	4202	-	-	-	-
	Super Colour	2786	2951	3111	3337	3497	3657	3821	3981	4208	4367	4661	-	-	-	-
	RAL Colour	2982	3142	3306	3595	3754	3919	4079	4238	4532	4692	5114	-	-	-	-
	Wood Effects	2688	2848	3002	3172	3327	3517	3672	3852	4007	4166	4321	-	-	-	-
	Satin	2637	2796	2961	3126	3286	3456	3620	3790	3950	4115	4275	-	-	-	-
3000 3125	White & Anthracite	3064	3219	3368	3517	3672	3821	3971	4125	4275	4424	4573	-	-	-	-
	Super Colour	3260	3414	3564	3780	3929	4079	4233	4383	4599	4748	5032	-	-	-	-
	RAL Colour	3456	3605	3760	4038	4187	4341	4491	4640	4923	5073	5485	-	-	-	-
	Wood Effects	3188	3337	3481	3636	3780	3945	4089	4254	4398	4558	4702	-	-	-	-
	Satin	3121	3270	3420	3574	3729	3883	4038	4192	4347	4501	4656	-	-	-	-

For Fixing Frame Sizes, please view pages 54 - 58.

For Optional Extras, see page 24.

For made to measure pricing, use the next size up.

Heights between 2125mm and 2225mm have cut top panels.

*For made to measure heights, panel heights may vary. Please contact before ordering.

Please note: Number of windows are provided as a guide based on door width - please check when ordering for actual number of windows.

SECTIONAL ISO 45 EVO OVERHEAD GARAGE DOORS CONTINUED

ISO 45 EVO FLUSH SMOOTH

Flush Smooth available in these Wood Effects finishes: Golden Oak, Dark Oak, Winchester, Night Oak

Flush Smooth available in these Satin finishes: Satin Black, Satin White, Satin Window Grey, Satin Dark Grey, Satin Brown, Satin Grey



Flush

	Width	2250	2375	2500	2750	3000	3250	3500	3750	4000	4250	4500	4750	5000	5250	5500
Height	No. of windows	3	3	3	4	4	4	4	4	5	5	6	6	6	6	7
1875 2000 2125	White & Anthracite	1906	1972	2034	2230	2421	2807	2936	3224	3301	3373	3517	3657	3760	3811	3863
	Super Colour	2101	2168	2230	2487	2683	3069	3198	3487	3626	3698	3971	4115	4218	4269	4383
	RAL Colour	2297	2364	2426	2750	2941	3327	3456	3744	3950	4022	4424	4568	4671	4723	4903
	Wood Effects	2065	2101	2163	2390	2580	3018	3142	3456	3528	3610	3749	3909	4012	4084	4135
	Satin	2045	2235	2302	2549	2745	3214	3342	3677	3754	3857	4002	4182	4285	4378	4434
2250	White & Anthracite	2009	2034	2060	2292	2524	2755	2987	3296	3389	3476	3595	3708	3811	3863	3914
	Super Colour	2204	2230	2256	2554	2786	3018	3250	3559	3713	3801	4048	4166	4269	4321	4434
	RAL Colour	2400	2426	2451	2812	3044	3275	3507	3816	4038	4125	4501	4620	4723	4774	4954
	Wood Effects	2168	2194	2215	2482	2709	2987	3219	3554	3641	3739	3852	3991	4094	4172	4218
	Satin	2276	2302	2333	2611	2848	3142	3378	3729	3826	3935	4058	4218	4321	4408	4465
2375 2500	White & Anthracite	2060	2075	2086	2390	2693	2997	3301	3605	3703	3796	3893	3986	4079	4249	4419
	Super Colour	2256	2271	2281	2652	2956	3260	3564	3868	4027	4120	4347	4439	4537	4707	4939
	RAL Colour	2451	2467	2477	2910	3214	3517	3821	4125	4352	4444	4800	4893	4990	5160	5459
	Wood Effects	2209	2220	2230	2565	2863	3219	3517	3863	3955	4063	4151	4264	4357	4532	4697
	Satin	2374	2390	2405	2760	3075	3461	3770	4141	4244	4367	4470	4614	4707	4893	5068
2625 2750	White & Anthracite	2343	2359	2369	2657	2946	3234	3523	3811	-	-	-	-	-	-	-
	Super Colour	2606	2616	2632	2920	3208	3497	3785	4074	-	-	-	-	-	-	-
	RAL Colour	2863	2879	2889	3178	3466	3754	4043	4331	-	-	-	-	-	-	-
	Wood Effects	2518	2529	2539	2848	3131	3487	3770	4094	-	-	-	-	-	-	-
	Satin	2704	2719	2735	3064	3358	3754	4048	4398	-	-	-	-	-	-	-
2875	White & Anthracite	2472	2678	2884	3090	3296	3502	3708	3914	-	-	-	-	-	-	-
	Super Colour	2668	2874	3080	3286	3492	3698	3904	4110	-	-	-	-	-	-	-
	RAL Colour	2863	3069	3275	3481	3687	3893	4099	4305	-	-	-	-	-	-	-
	Wood Effects	2657	2858	3059	3286	3487	3749	3950	4192	-	-	-	-	-	-	-
	Satin	2848	3059	3265	3512	3723	4027	4238	4506	-	-	-	-	-	-	-
3000 3125	White & Anthracite	3064	3214	3363	3507	3657	3801	3950	4094	-	-	-	-	-	-	-
	Super Colour	3260	3409	3554	3703	3852	3996	4146	4290	-	-	-	-	-	-	-
	RAL Colour	3456	3605	3749	3899	4043	4192	4341	4486	-	-	-	-	-	-	-
	Wood Effects	3301	3445	3590	3754	3899	4063	4208	4383	-	-	-	-	-	-	-
	Satin	3523	3677	3826	4017	4172	4357	4517	4717	-	-	-	-	-	-	-

Size availability (mm) for Made to Measure doors (Internal frame size).

For Fixing Frame Sizes, please view pages 54 - 58.

All ISO 45 EVO (apart from Panelled)

Min Width	1800
Max Width	5500
Min Height	1800
Max Height	3125

For made to measure pricing, use the next size up.

Heights between 2125mm and 2225mm have cut top panels.

Doors over 2750mm high will come with torsion gearing.

*For made to measure heights, panel heights may vary. Please contact before ordering.

For Optional Extras, see page 24.

Please note: Number of windows are provided as a guide based on door width - please check when ordering for actual number of windows

SECTIONAL ISO 45 EVO OVERHEAD GARAGE DOORS CONTINUED

ISO 45 EVO MICROLINE

Microline available in these Satin finishes: Satin White, Grey, Dark Grey, Window Grey.



Microline

	Width	2250	2375	2500	2750	3000	3250	3500	3750	4000	4250	4500	4750	5000	5250	5500
Height	No. of windows	3	3	3	4	4	4	4	4	5	5	6	6	6	6	7
1875 2000 2125	Satin	1942	2132	2328	2518	2709	2899	3095	3286	3476	3667	3863	4053	4244	-	-
2250	Satin	2230	2405	2585	2760	2936	3111	3291	3466	3641	3816	3996	4172	4347	-	-
2375 2500	Satin	2446	2652	2858	3069	3275	3481	3687	3899	4105	4311	4517	4723	4934	-	-
2625 2750	Satin	2843	3054	3270	3487	3703	3914	4130	4347	4563	4779	4996	-	-	-	-
2875	Satin	2956	3167	3373	3579	3785	3996	4202	4408	4614	4826	5032	-	-	-	-
3000 3125	Satin	3641	3806	3976	4141	4311	4475	4645	4810	4980	5145	5315	-	-	-	-

Minimum sizes 2000mm Width and 1875mm Height

For Fixing Frame Sizes, please view pages 54 - 58.

ISO 45 EVO Sectional doors

up to 2125mm - 4 panels high

up to 2500mm 5 - panels high

up to 3000mm - 6 panels high

Heights between 2125mm and 2225mm have cut top panels.

For made to measure pricing, use the next size up.

*For made to measure heights, panel heights may vary.
Please contact before ordering.

For Optional Extras, see page 24.

Please note: Number of windows are provided as a guide based on door width - please check when ordering for actual number of windows

SECTIONAL ISO 45 EVO OVERHEAD GARAGE DOORS CONTINUED

OPTIONAL EXTRAS FOR ISO 45 EVO

Sectional frame heads are colour matched to the door as standard.

Frame leg cover profiles 2.5 m length

White / Anthracite	85mm x 20mm (per pair)	£124
	55mm x 20mm (per pair)	£124
Super Colour	85mm x 20mm (per pair)	£134
	55mm x 20mm (per pair)	£134
RAL colour	85mm x 20mm (per pair)	£206
	55mm x 20mm (per pair)	£206
Wood Effects & Satins	85mm x 20mm (per pair)	£206
	55mm x 20mm (per pair)	£206

Please note: Cover profiles cannot be supplied in the following laminate finishes but will be provided in the following colours:

Night Oak Profiles = RAL 8022 Black Brown

Winchester Profiles = RAL 8001 Ochre Brown

Super Colour Options

Stone Grey RAL 7030, Moss Green RAL 6005, Fir Green RAL 6009, Light Grey RAL 7035, Window Grey RAL 7040, White Aluminium RAL 9006, Quartz Grey RAL 7039, Basalt Grey 7012, Grey Aluminium RAL 9007, Slate Grey RAL 7015, Nut Brown RAL 8011, Sepia Brown RAL 8014, Dark Grey DB 703, Black RAL 9005

Wood effects (smooth finish) - ISO 45 EVO only

Golden Oak, Dark Oak, Winchester, Night Oak

Structural surfaces - ISO 45 EVO only (excl. panelled doors)

Satin Black, Satin White RAL 9016, Satin Window Grey RAL 7040, Satin Dark Grey RAL 7016, Satin Brown RAL 8014, Satin Grey (Composite Shade)

Microline pattern - ISO 45 EVO only

Satin White, Grey, Dark Grey, Window Grey

Equivalent RAL colours for painted window frames

Dark Oak (RAL 8028), Satin White (RAL 9016) Satin Grey (RAL7011), Satin Dark Grey, (RAL 7016), Satin Window Grey (RAL 7040), Satin Brown (RAL 8014), Night Oak* (RAL 8022), Winchester* (RAL 8001)

*All colour profiles have matching finishes except for Night Oak and Winchester which are painted.

Colour variations may occur due to production processes.

Window option clear/crystal, V1, V2, V3 (per window)

White frame **£176**
Super Colour or RAL frame **£201**

Window option clear/crystal, V4D, V4S (per window)

White frame **£191**
Super Colour or RAL frame **£206**

Window option clear/crystal, V7 Aluminium Light Strip (per window)

£603

Window option clear/crystal V8 Porthole

Large Rib and Flush doors only (Per window)

£618

Window option clear/crystal

V9 Square

(Per Window)

£588

Options

Manual locking with Black D Handle

£109

Metal 'D' handles (White, Black)

£206

Metal lever door handles (White, Black, Silver)

£315

Low Headroom Kit

£227

Ventilation grilles to suit (per grill)

£73

Automated Options

Page 36

Wicket doors only available in ISO 45 EVO

See page 25

Sectional doors are bespoke and made to order.

SECTIONAL ISO 20/45 OVERHEAD GARAGE DOORS CONTINUED

GLAZING OPTIONS - SECTIONAL ISO 20/45 OVERHEAD GARAGE DOORS

V1, V2, V3, V4D, V4S
Window Sizes as standard 457mm (w) 260mm (h)



V1
Plain clear / crystal



V2
Rhombus clear / crystal



V3
Cross clear / crystal

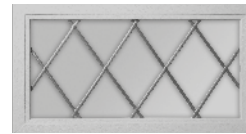

V4D
Diamond leaded clear / crystal



V4S
Square leaded clear / crystal

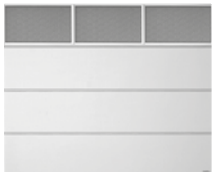

V7 Light Strip **£603**
per window

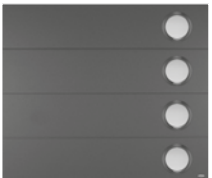

V8 Portholes **£618**
per window



V9 Square **£588**
per window

Sunrise Pattern Glazing

ISO 45 EVO panelled doors, standard sizes. Colour matched options available.

Co-ord. width 2000 - 2600mm



Add £629

Co-ord. width 2601 - 3500mm



Add £814

Co-ord. width 3501 - 4000mm



Add £1113

Co-ord. width 4001 - 4500mm



Add £1221

Co-ord. width 4501 - 5500mm



Add £1324

*V8 & V9 windows cannot be colour matched. Only available in Stainless Steel.

Sunrise glazing may will carry an additional lead time. Please contact before ordering.

WICKET DOORS

ISO 45 EVO for horizontal rib, large rib, panelled and flush (woodgrain white and smooth finish) size exceptions occur, check when ordering **add £1983**.

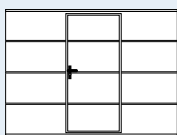

Wicket Door - Flush

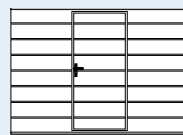

Wicket Door - Large Rib

Metal lever door handles (White, Black)

Add £317

Low head rear mount kit for ISO 45 EVO doors where required

Add £227

3-Point Locking

Add £181

Wicket doors include contact kit as standard. Outwards opening only.

Double sectional doors can only have the wicket on the left or right. Wicket doors come with a colour-matched surround.

Minimum Width 2000mm Maximum Width 5000mm. (Panelled - Minimum Width 2250mm. Minimum Height 1875mm).

3 dimensional fitting brackets

£124

Perfect fixing brackets for door frames in case of slanted side walls, often used for pre-fabricated concrete garages. Fixing bracket adjustable from 70 - 110°. Pack of ten.

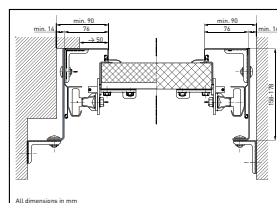

Between fix frame brackets

£100

Between fix frame brackets (rear mount doors only). Use when fitting between aperture or limited sideroom. Bridges bricks or insulation cavity.

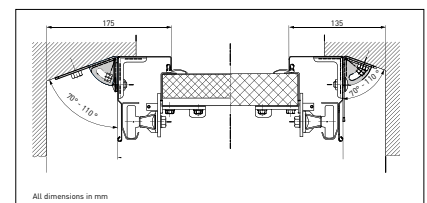







SECTIONAL MATCHING SIDE DOORS

SECTIONAL ISO 45 EVO MATCHING SIDE GARAGE DOORS

WHITE

Matching side doors are supplied as standard with matching colour tubular aluminium block frame

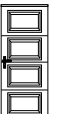
Matching Side Doors - Door order reference (w x h) - to match ISO 20 and ISO 45 EVO insulated sectional garage doors

Imperial	Metric	Overall Frame Size	Horizontal Rib / Large Rib (woodgrain)	Flush (woodgrain)	Large Rib (smooth)	Flush (smooth)	Panelled (woodgrain)	Panelled Glazed (woodgrain)
2'10" x 6'6"	875 x 2000	955 x 2040						
2'10" x 6'6"	875 x 2000	955 x 2040	1777	2024	1777	2153	2137	2312
2'10" x 7'0"	875 x 2125	955 x 2165	1777	2024	0	2153	2137	2312
3'3" x 6'6"	1000 x 2000	1080 x 2040	-	2101	1869	2245	2220	2400
3'3" x 7'0"	1000 x 2125	1080 x 2165	1869	2101	-	2245	2220	2400
3'6" x 6'6"	1100 x 2000	1180 x 2040	-	2168	1900	2323	-	-
3'6" x 7'0"	1100 x 2125	1180 x 2165	1900	2168	-	2323	-	-
Made to Measure sizes	730 to 1350 x 1815 to 2500	810 to 1430 x 1855 to 2540	2348	2426	2348	2518	-	-



For Fixing Frame Sizes, please view pages 59 - 60.

Special sizes available on request.

RAL colours Add £385 for door panel
 Super Colours Add £195 per door panel
 Matching frame Add £65

SATIN BLACK, SATIN WHITE, SATIN WINDOW GREY, SATIN DARK GREY, SATIN BROWN, SATIN GREY

Matching Side Doors - Door order reference (w x h) - to match ISO 45 EVO insulated sectional garage doors

Imperial	Metric	Overall frame size	Microline	Large Rib	Flush Smooth
					
2'10" x 6'6"	875 x 2000	955 x 2040	2663	2323	2663
2'10" x 7'0"	875 x 2125	955 x 2165	2663	2323	2663
3'3" x 6'6"	1000 x 2000	1080 x 2040	2735	2467	2735
3'3" x 7'0"	1000 x 2125	1080 x 2165	2735	2467	2735
Made to Measure sizes	730 to 1350 x 1815 to 2500	810 to 1430 x 1855 to 2540	2843	2549	2843

Microline not available in Satin Brown





Special sizes available on request.

For Fixing Frame Sizes, please view pages 59 - 60.

SECTIONAL ISO 45 EVO MATCHING SIDE GARAGE DOORS

GOLDEN OAK, DARK OAK, WINCHESTER AND NIGHT OAK

Matching Side Doors - Door order reference (w x h) - to match ISO 45 EVO insulated sectional garage doors

Imperial	Metric	Overall Frame Size	Large Rib	Flush	Flush Glazed	Panelled	Panelled Glazed
2'10" x 6'6"	875 x 2000	955 x 2040					
2'10" x 7'0"	875 x 2125	955 x 2165	2127	2405	2575	2446	2621
3'3" x 6'6"	1000 x 2000	1080 x 2040	2266	2529	2699	2585	2760
3'3" x 7'0"	1000 x 2125	1080 x 2165	2266	2529	2699	2585	2760
3'6" x 6'6"	1100 x 2000	1180 x 2040	2338	2632	-	-	-
3'6" x 7'0"	1100 x 2125	1180 x 2165	2338	2632	-	-	-
Made to Measure sizes	730 to 1350 x 1815 to 2500	810 to 1430 x 1855 to 2540	2678	2796	3713	3641	3811

Panelled in Golden Oak and Dark Oak only

Special sizes available on request.

For Fixing Frame Sizes, please view pages 59 - 60.

Matching side doors are bespoke and made to order.

Min Width	810
Max Width	1400
Min Height	1900
Max Height	2500

Note: sizes listed are overall frame size.

ISO 45 EVO

THE PREMIUM SECTIONAL GARAGE DOOR WITH THERMAL BREAK



✓ Additional seal in the section head.

✓ The new, optimised steel sections are manufactured exclusively in a double-skinned, thermally broken sandwich construction with a thickness of 45 mm.

✓ Exceptionally good heat insulation value for the section of $U(p) = 0.46 \text{ W/m}^2\text{K}^*$

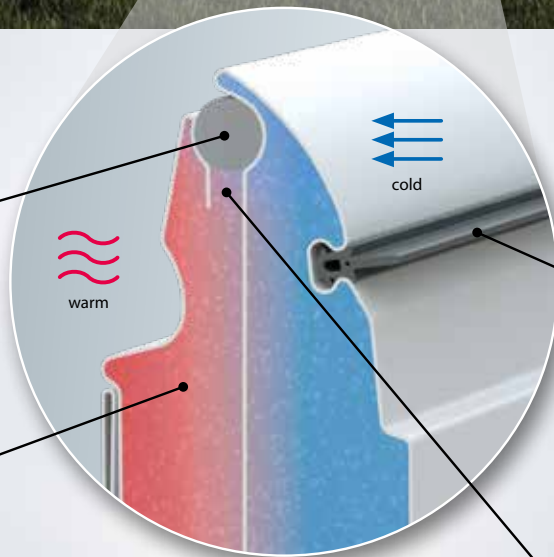

✓ Additional insulating seal between the sections for even better heat insulation.

✓ Thermal break between the door's outer and inner shells.

Insulation depth

*With respect to door solutions with comparable section thicknesses. Performance dependent on door pattern and size.

Novoferm Sectional Door Specifications

All Novoferm ISO 20 steel overhead sectional garage doors are supplied 20mm thick double skinned steel sections made of hot galvanised thin sheet, with CFC free PUR rigid foam (insulation value $k=1.0 \text{ W/m K}$) giving good heat and sound insulation, anti pinch profile.

All Novoferm ISO 45 EVO steel overhead sectional garage doors are supplied 45mm thick double skinned steel sections made of hot galvanised thin sheet, with CFC free PUR rigid foam (insulation value $k=0.5 \text{ W/m K}$) giving excellent heat and sound insulation, anti pinch profile.

All Novoferm overhead sectional doors can be supplied with locking if required as an extra, this will be drilled on the right hand side viewed from outside as standard unless otherwise requested. Novoferm ISO 20 and ISO 45 EVO steel overhead sectional door panels are supplied in woodgrain and smooth surface pattern, a pre-finished polyester exterior coating (RAL 9016 as standard). All sections are prepared for mounting hardware, floor profile, floor seal and locking (if required).

All Novoferm ISO 20 steel overhead sectional garage doors are supplied with triple safety extension spring assemblies positioned to the rear of the vertical frame legs.

All Novoferm ISO 45 EVO overhead sectional garage doors are supplied with triple safety extension spring assembly positioned to the rear of the vertical frame legs for doors under 3 metres wide x 2.7 metres high.

All Novoferm ISO 45 EVO overhead sectional doors over 3 metres wide x 2.7 metres high are supplied with front mounted torsion spring shafts and galvanised torsion springs as standard, spring break safety feature tested in accordance with DIN EN 12604 and steel lifting cables. (Optional low headroom kit may be added if required).

All Novoferm ISO 20 and ISO 45 EVO overhead sectional garage doors are supplied with angle frames and fascia panel made of hot galvanised thin sheet steel with a smooth surface pre-finished polyester coating (white RAL 9016 as standard), frame and fascia seals are black EPDM rubber, colour matched leg profile covers are available as an optional extra.

All Novoferm garage doors and operators are manufactured according to the strict quality management system ISO 9001.

- All sectional garage door systems meet the high safety requirements of the European garage doors standard EN 13241.
- All Novoferm garage doors and operators are tested by recognised institutes both individually and in combination.
- At Novoferm, all garage door operators are tested in combination with all Novoferm garage doors, and comply with current standards and rulings, thus eliminating the possibility of incorrect application.
- **“TÜV-tested burglar resistance”:** The German industry association for garage doors, doors and frames (Industrieverband Tore Türen Zargen) has drawn up a guideline that defines burglar resistance based on the existing standards. TÜV NORD CERT GmbH tests and certifies the garage doors: Novoferm’s certified garage doors guarantee the highest levels of safety tested by an impartial organisation.



10 | up to 10 Years
Novoferm Warranty



NOVOROL 77 ROLLER GARAGE DOORS (FULL BOX INCLUDED)

Novorol 77 are supplied with 70mm or 90mm colour matched guides, full box as standard, hard wired control safety system and 2 no. 2-channel hand transmitters. Automated as standard.

POLYESTER PAINT FINISH

Available in following colours: Traffic White (RAL 9016), Jet Black (RAL 9005), Anthracite Grey (RAL 7016), Chartwell Green (BS4800), Blue (RAL 5011), Rosewood, Racing Green (RAL 6009), Golden Oak, Agate Grey (RAL 7038), Brown (RAL 8014), Burgundy (RAL 3004), Mocca (RAL 8019), Cream (RAL 9001).

Other RAL colours available but will carry an additional lead time. POA.

Guide Height (up to)		Overguide width (up to)						
	Metric	2300mm	2500mm	3000mm	3500mm	4000mm	4500mm	5000mm
Guide Height (up to)	2000mm	2462	2462	2668	3116	3193	3414	3785
	2125mm	2524	2524	2740	3142	3245	3487	3852
	2250mm	2606	2606	2822	3193	3296	3569	3935
	2375mm	2704	2704	2920	3245	3399	3667	4032
	2500mm	2812	2812	3028	3270	3456	3780	4146
	2743mm	2936	2936	3157	3348	3579	3904	4275

TEXTURED WOODGRAIN FINISH

Available in following colours: Golden Oak and Rosewood.

Guide Height (up to)		Overguide width (up to)						
	Metric	2300mm	2500mm	3000mm	3500mm	4000mm	4500mm	5000mm
Guide Height (up to)	2000mm	3008	3008	3394	3981	4305	4671	5176
	2125mm	3131	3131	3451	3996	4341	4728	5227
	2250mm	3265	3265	3512	3991	4352	4867	5428
	2375mm	3404	3404	3693	4120	4506	5150	5598
	2500mm	3538	3538	3966	4444	4882	5526	5928
	2743mm	3672	3672	4027	4311	5109	5444	6824

Min Width: 1400 | Max Width: 5000
Min Height: 1831 | Max Height: 2743

OPTIONAL EXTRAS

Low level emergency release kit **Add £309**

Somfy motor - Single door size
(Up to 3000mm Overguide width) **£300**

Somfy motor - Double door size
(Over 3000mm overguide width) **£360**

Vision lath (Novorol 77 only) **POA**

Please note vision laths are only available for doors in Black, White and Anthracite Grey. All Novorol doors are bespoke and made to order.

NEW SPECIFICATION

Half or no box available. Priced on Application. Please state on order

Up to 3 metre (OGW) 70mm Guides / over 3 Metre (OGW) - 90mm guides

Somfy Rollixo RTS Control units supplied as standard with Novorol 77.
Novorol NR 20 & Teleco operators available on request.

All Novorol 77 doors are supplied with 300mm Steel end plates as standard.
Ordered with no box are supplied 270mm steel end plates which are not suitable for full or half boxes.

Novorol doors come with hard wired safety edge as standard, wireless safety edge is available at no extra costs

Doors above 2300mm height will come supplied with a 360mm box.

NOVOROL 55 ROLLER GARAGE DOORS (FULL BOX INCLUDED)

Novorol 55 are supplied with 65mm colour matched guides, full box as standard, hard wired control safety system and 2 no. 2-channel hand transmitters.

POLYESTER PAINT FINISH

Available in following colours: Traffic White (RAL 9016), Jet Black (RAL 9005), Anthracite Grey (RAL 7016), Chartwell Green (BS4800), Blue (RAL 5011), Rosewood, Racing Green (RAL 6009), Golden Oak, Agate Grey (RAL 7038), Brown (RAL 8014), Burgundy (RAL 3004), Mocca (RAL 8019), Cream (RAL 9001).

Other RAL colours available but will carry an additional lead time. POA.

Guide Height (up to)		Overguide width (up to)		
	Metric	2300mm	2500mm	3000mm
Guide Height (up to)	2000mm	2220	2271	2405
	2125mm	2271	2338	2467
	2250mm	2348	2410	2544
	2286mm	2436	2498	2632

TEXTURED WOODGRAIN FINISH

Available in following colours: Golden Oak, Rosewood.

Guide Height (up to)		Overguide width (up to)		
Imperial	Metric	2300mm	2500mm	3000mm
Guide Height (up to)	2000mm	2843	2951	3430
	2125mm	2807	2966	3548
	2250mm	3198	3013	3600
	2286mm	3208	3116	3574

Minimum Width	1600
Maximum Width	3000
Minimum Height	1831
Maximum Height	2286

OPTIONAL EXTRAS

Low level emergency release kit **Add £309**

Somfy motor - Single door size (Up to 3000mm overguide width) **£300**

NEW SPECIFICATION

Novorol 55 Doors are only available with a full box and the end plates are 205mm.

Somfy Rollixo RTS Control units supplied as standard with Novorol 55.

Up to 3 metre (OGW) 65mm Guides

Novorol NR 20 & Teleco control units available on request.

Novorol doors come with hard wired safety edge as standard, wireless safety edge is available at no extra costs

GRP UP & OVER SINGLE GARAGE DOORS (FRAME INCLUDED)

C = Canopy gear, R = Retractable gear.

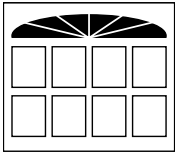
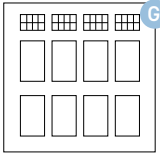
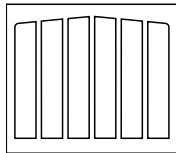
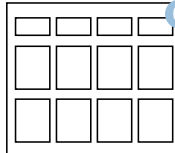
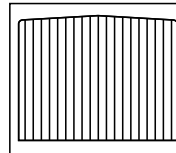
Internal Frame Size Door Order Ref. (W x H)											
Imperial	Metric	C	R	C	R	C	R	C	R	C	R
7'0" x 7'0"	2134 x 2134	2965	3051	2619	2711	2965	3051	2965	3051	2965	3051
7'0" x 7'6"	2134 x 2286	-	-	2824	2916	-	-	3170	3256	-	-
7'6" x 7'0"	2286 x 2134	3380	3467	2727	2813	3380	3467	3380	3467	3380	3467
7'6" x 7'6"	2286 x 2286	-	-	2932	3019	-	-	3586	3672	-	-
8'0" x 7'0"	2438 x 2134	3478	3564	2786	2878	3478	3564	3478	3564	3478	3564
8'0" x 7'6"	2438 x 2286	-	-	2992	3078	-	-	3683	3769	-	-

Size availability (mm) for Made to Measure doors

Minimum Width	2032	2032	2032	2032	2032	2032	2032	2032	2032	1981	1981
Maximum Width	2438	2438	2438	2540	2438	2438	2438	2438	2438	2438	2388
Minimum Height	1930	1880	1930	1880	1981	1880	1930	1880	1930	1880	1981
Maximum Height	2134	2134	2134	2286	2134	2134	2286	2286	2286	2134	2134

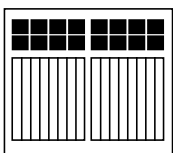
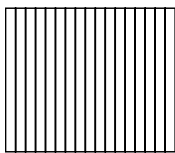
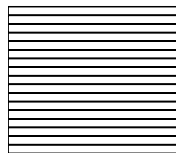
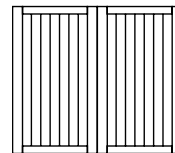
Internal Frame Size Door Order Ref. (W x H)									
Imperial	Metric	C	R	C	R	C	R	C	R
7'0" x 7'0"	2134 x 2134	-	-	2965	3051	2965	3051	2965	3051
7'0" x 7'6"	2134 x 2286	-	-	3170	3256	3170	3256	3170	3256
7'6" x 7'0"	2286 x 2134	3526	3618	3380	3467	3380	3467	3380	3467
7'6" x 7'6"	2286 x 2286	-	-	3586	3672	3586	3672	3586	3672
8'0" x 7'0"	2438 x 2134	3629	3715	3478	3564	-	-	3478	3564
8'0" x 7'6"	2438 x 2286	-	-	3683	3769	-	-	3683	3769

G = Available as Glazed door

Size availability (mm) for Made to Measure doors (Internal frame size).

Minimum Width	2261	2235	1956	1981	1956	1981	2134	2134
Maximum Width	2438	2590	2438	2438	2286	2286	2438	2540
Minimum Height	1931	1880	1880	1880	1880	1880	1981	1981
Maximum Height	2134	2286	2134	2286	2134	2286	2134	2286

OPTIONAL EXTRAS

Please note when trying to colour match garage doors with other UPVC products, always check a colour sample first. For example, Rosewood GRP doesn't match Rosewood UPVC where Dark Mahogany GRP is a closer match.

Single GRP Door Options

Woodgrain colour options

White, Magnolia, Bleached Oak, Red Mahogany, Dark Mahogany, Light Oak, Dark Oak, Irish Oak, Honey Beech, Teak, Rosewood, Golden Brown, Ebony, Anthracite Grey

Woodgrain colour options at additional cost

Blue, Red, Green **£365**
RAL colour of your choice **£725**

High gloss options included in the price as standard.

Gloss White and Gloss Magnolia

Steel frame colour options

Essential colour steel frame & chassis **Incl. FOC**
Standard & Elite colour steel frame & chassis **£230**
(See our colour options on Page 14)

All GRP Canopy are in a chassis with a 45mm head frame and 54mm legs
Retractable will be a solid door without a chassis in a 68mm all round frame.

Glazing options are available as follows:

Lydbrook & Glossop **£237**
Black Mock **£474**
Clear or Stippled **POA**
Leading - Diamond Lattice / Queen Anne Lattice / Square Lattice **£593**
Shildon (Black Mock as standard) **£546**
Clear or Stippled **£546**

GRP UP & OVER DOUBLE GARAGE DOORS (FRAME INCLUDED)

CONTINUED

G = Available as Glazed door

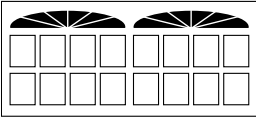
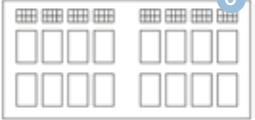
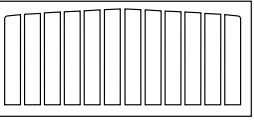
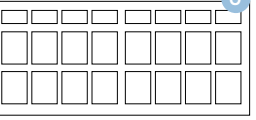
Internal Frame Size Door Order Ref. (W x H)		 CHERTSEY GLOSS	 GLOSSOP GLOSS	 HAMILTON WOODGRAIN	 LYDBROOK WOODGRAIN
Imperial	Metric	R	R	R	R
9'0" x 7'0"	2743 x 2134	-	3785	-	4088
10'0" x 7'0"	3048 x 2134	-	4120	-	4374
11'0" x 7'0"	3353 x 2134	-	4547	-	4757
12'0" x 7'0"	3658 x 2134	-	4833	-	5276
13'0" x 7'0"	3962 x 2134	-	4882	-	5470
14'0" x 7'0"	4267 x 2134	5427	4882	5567	5567
15'0" x 7'0"	4572 x 2134	6183	5611	6377	6183
16'0" x 7'0"	4724 x 2134	-	6448	-	6566

Size availability (mm) for Made to Measure doors (Internal frame size).

Minimum Width	4115	2743	4115	2515
Maximum Width	4572	4877	4724	4877
Minimum Height	1930	1930	1981	1930
Maximum Height	2134	2286	2134	2134

R = Retractable gear.

Retractable will be a solid door without a chassis in a 68mm all round frame.

Double GRP Door Options

Woodgrain colour options

White, Magnolia, Bleached Oak, Red Mahogany, Dark Mahogany, Light Oak, Dark Oak, Irish Oak, Honey Beech, Teak, Rosewood, Golden Brown, Ebony, Anthracite Grey

Woodgrain colour options at additional cost

Blue, Red, Green **£725**
RAL colour of your choice (set price) **£970**

High gloss options included in the price as standard.

Gloss White and Gloss Magnolia

Steel frame colour options

Essential colour steel frame & chassis **Incl. FOC**
Standard & Elite colour steel frame & chassis **£430**
(See our colour options on Page 14)

Glazing options are available as follows:

Lydbrook & Glossop Black Mock	£474
Clear or Stippled	£1020
Leading - Diamond Lattice / Queen Anne Lattice / Square Lattice Shildon (Black Mock as standard)	POA
Clear or Stippled	£1273
Chertsey (Black Mock as standard) Clear or Stippled	£1067

Please note when trying to colour match garage doors with other UPVC products, always check a colour sample first. For example, Rosewood GRP doesn't match Rosewood UPVC where Dark Mahogany GRP is a closer match.

GRP UP & OVER DOUBLE GARAGE DOORS (FRAME INCLUDED)

CONTINUED

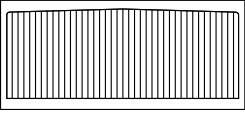
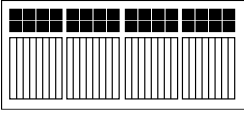
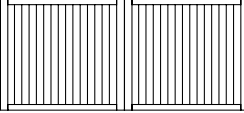
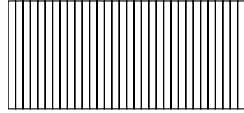
Internal Frame Size Door Order Ref. (W x H)		 NEWBURY WOODGRAIN	 SHILDON WOODGRAIN	 KENTLEY WOODGRAIN	 VIRGINIA WOODGRAIN
Imperial	Metric	R	R	R	R
9'0" x 7'0"	2743 x 2134	-	-	-	4088
10'0" x 7'0"	3048 x 2134	-	-	-	4374
11'0" x 7'0"	3353 x 2134	-	-	-	4757
12'0" x 7'0"	3658 x 2134	-	-	-	5276
13'0" x 7'0"	3962 x 2134	-	-	-	5470
14'0" x 7'0"	4267 x 2134	5567	5611	5567	5567
15'0" x 7'0"	4572 x 2134	-	6183	6183	6183
15'6" x 7'0"	4724 x 2134	-	-	6566	6566
16'0" x 7'0"	4877 x 2134	-	-	-	6259

Size availability (mm) for Made to Measure doors (Internal frame size).

Minimum Width	4115	4267	4267	2743
Maximum Width	4267	4572	4724	4877
Minimum Height	1981	1905	2134	1905
Maximum Height	2134	2286	2286	2286

R = Retractable gear.

Retractable will be a solid door without a chassis in a 68mm all round frame.

Double GRP Door Options

Woodgrain colour options

White, Magnolia, Bleached Oak, Red Mahogany, Dark Mahogany, Light Oak, Dark Oak, Irish Oak, Honey Beech, Teak, Rosewood, Golden Brown, Ebony, Anthracite Grey

Woodgrain colour options at additional cost

Blue, Red, Green **£725**
RAL colour of your choice (set price) **£970**

High gloss options included in the price as standard.

Gloss White and Gloss Magnolia

Steel frame colour options

Essential colour steel frame & chassis **Incl. FOC**
Standard & Elite colour steel frame & chassis **£430**
(See our colour options on Page 14)

Glazing options are available as follows:

Lydbrook & Glossop Black Mock	£474
Clear or Stippled	£1020
Leading - Diamond Lattice / Queen Anne Lattice / Square Lattice Shildon (Black Mock as standard)	POA
Clear or Stippled	£1273
Chertsey (Black Mock as standard) Clear or Stippled	£1067

Please note when trying to colour match garage doors with other UPVC products, always check a colour sample first.
For example, Rosewood GRP doesn't match Rosewood UPVC where Dark Mahogany GRP is a closer match.

GRP DOUBLE SIDE HINGED GARAGE DOORS (FRAME INCLUDED)

Double side hinged, internal frame sizes, with GRP infill - frame included in price.

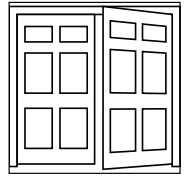
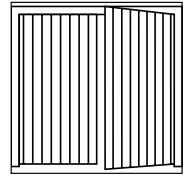
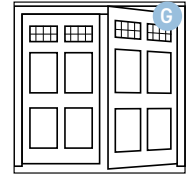
Internal Frame Size Door Order Ref. (W x H)		Overall Frame Size				
Imperial	Metric		SHILDON WOODGRAIN (1/2 - 1/2)	LYDBROOK WOODGRAIN (1/2 - 1/2)	VIRGINIA WOODGRAIN (1/2 - 1/2)	GLOSSOP GLOSS (1/2 - 1/2)
7'0" x 7'0"	2134 x 2134	2234 x 2184	3893	3596	3596	3596
7'6" x 7'0"	2286 x 2134	2386 x 2184	4050	3742	3742	3742
8'0" x 7'0"	2438 x 2134	2538 x 2184	4174	3850	3850	3850

Size availability (mm) for Made to Measure doors (Internal frame size).

Minimum Width	2134	2134	1830	2134
Maximum Width	2438	2438	2438	2438
Minimum Height	1930	1930	1840	1930
Maximum Height	2134	2134	2134	2134

For made to measure pricing, please use next size up.

Doors supplied as standard right hand opening when viewed from outside. All side hinged doors are only available opening outwards.

GRP Double Side Hinged Door Options

Steel frame colour options

Essential colour steel frame & chassis	Incl. FOC
Standard colour steel frame & chassis	£200
Elite colour steel frame & chassis	£230

(See our colour options on Page 14)

50mm frame supplied as standard

Left hand opening **Add £129**

All GRP side hinged doors come complete with door stays.

GRP MATCHING SIDE DOOR

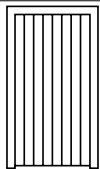
Internal Frame Size Door Order Ref. (W x H)		Overall Frame Size	
Imperial	Metric		Virginia glasswood
7'0" x 7'0"	2134 x 2134	2234 x 2184	2198

Size availability (mm) for Made to Measure doors (Internal frame size).

Minimum Width	720
Maximum Width	1220
Minimum Height	1930
Maximum Height	2134

Woodgrain colour options

White, Magnolia, Bleached Oak, Red Mahogany, Dark Mahogany, Light Oak, Dark Oak, Irish Oak, Honey Beech, Teak, Rosewood, Golden Brown, Ebony, Anthracite Grey

Woodgrain colour options at additional cost

Blue, Red, Green **£725**

RAL colour of your choice (set price) **£970**

High gloss colour options standard as price list Gloss White and Gloss Magnolia

Glazing options are available as follows:

Lydbrook & Glossop **£237**
Black Mock

Clear or Stippled **£474**

Leading - Diamond Lattice / Queen Anne Lattice / Square Lattice **POA**
Shildon (Black Mock as standard)

Clear or Stippled **£593**

GRP Side Door Options

Steel frame colour options

Essential colour steel frame & chassis	Incl. FOC
Standard colour steel frame & chassis	£75
Elite colour steel frame & chassis	£115





(See our colour options on Page 14)

50mm frame supplied as standard

For made to measure pricing, please use next size up.

Please note when trying to colour match garage doors with other UPVC products, always check a colour sample first. For example, Rosewood GRP doesn't match Rosewood UPVC where Dark Mahogany GRP is a closer match.

GARAGE DOOR OPERATORS

	<p>Product code OP00141</p>	<p>Novomatic 443 Energy saving with 0.5 Watt power supply in stand-by mode Power supply: 230V / 50Hz Pull and push force: 600N Running speed: 18cm/s Maximum door area: 10m2 App Control available CE marked</p>	<p>£428</p>
	<p>Product code OP00142</p>	<p>Novomatic 573 S Energy saving with 0.5 Watt power supply in stand-by mode Power supply: 230V / 50Hz Pull and push force 800N Running Speed: 24cm/s Maximum door area: 18m2 App Control available CE marked</p>	<p>£505</p>
	<p>Product code OP00083B</p>	<p>Bi-directional Adjustment module and Gateway New Generation Smart Home garage door system, for control of your door through app, comes with module and gateway using Homematic IP system, compatible with Alexa and Google Home. One module supplied as standard, for control of additional motors request additional modules. *Must be purchased with through-beam photocells.</p>	<p>£340</p>
	<p>Product code OP00112</p>	<p>Smart Garage Module Extra module for Homematic IP gateway, required for each additional door.</p>	<p>£150</p>

NOVOMATIC RANGE AT A GLANCE

- Comfortable handling due to tamper resistant rolling code Adjustento system.
- Soft-Start, Soft Stop function for whisper quiet door running.
- Integrated automatic switch-off, which stops the door safely in case of obstacles.
- Electronic observed anti-opening safety for making the door burglar resistant.
- Bright LED lighting (programmable 60-240 sec.).
- Directly connectable outside lighting up to 500 Watt.
- Automatic closing after a set time can be programmed (opto sensor required).
- Internal quick release cable for manual over ride in case of power failure.
- Simple and fast mounting due to standard door fitting for up-and-over and sectional doors.

NOVOPORT® GARAGE DOOR OPERATORS

	<p>NovoPort® Speed Operator</p> <p>Energy saving with <0.5 Watt power supply in stand-by mode. Power supply: 230v / 50Hz Tensile and compressive force: 650N Running Speed: 29cm/s Maximum door area: 17m2 App Control available CE marked</p>	<p>£470</p>
-----------------------------------------------------------------------------------	----------------------------------------------------------------------------------------------------------------------------------------------------------------------------------------------------------------------------------------------------------------------------------------------------------------------------------------	--------------------

NOVOPORT® FEATURES AT A GLANCE

- Integrated high speed function for door opening that is up to 50% faster (up to 29cm/s)
- Modern and 20% flatter casing with continuous LED Strip for energy saving and bright illumination.
- Integrated, indirect lighting with LED (6 Watt) switched on automatically when opening.
- Automatic closing after a set time can be programmed (opto sensor required).
- The door can be operated by app or voice command.
- Simple integration in existing smart home systems.

POWER OPERATED GARAGE DOORS

It is against the law to install a power operated garage door in the UK without complying with The Machinery Directive.

To comply with the Machinery Directive both the door and the operator used in the Installation must have a declaration of Incorporation from the manufacturer.

On completion of the installation the Installer must provide a Declaration of conformity and apply a CE mark giving details of the installation (as example) to the door / operator combination, which is now classed as a machine.

The Installer must issue to the Customer a declaration of conformity on the completion of the installation.

The Installer must hold copies of both the Declarations of Incorporation and the Declaration of Conformity on a technical file for inspection by the relevant authorities.

If any of the above requirements are not fulfilled the Installation is illegal.

Please ensure for your own safety and peace of mind that whoever installs your electric operator is both willing and able to fulfil these requirements; if they are not - do not use them!!

Members of the DHF Garage Door Group CAN and WILL install your Novoferm operator safely and legally.

UNIQUE TECHNOLOGY WITH FLEXIBLE SIDE MOUNTING FOR NOVOFERM SECTIONAL GARAGE DOORS

Exclusively available from Novoferm, the NovoPort Speed operator is specifically designed for sectional garage doors. It features a sleek new design, smart home functionalities, energy efficient and a host of additional user-friendly features.

Unlike conventional ceiling-mounted operators, the NovoPort Speed's control unit is conveniently installed on the left or right wall, allowing effortless garage access with an integrated push button, eliminating the need for extra wall-mounted controls.

Breaking from tradition, the NovoPort Speed operator is the only side mounted operator on the market. Instead of being fixed to the ceiling, it is integrated into the side door track. This innovative approach keeps the ceiling clear and eliminates common installation challenges, making it ideal for in-between fits and low ceilings.



novoferm

Intelligent Door Solutions

Open the Door to **SMART LIVING**

At Novoferm, we lead the way with our range of premium automatic garage doors that offer more than just security, they make a statement.

Bespoke, Made to Measure Products

**World Leading Manufacturer of
Garage Door Systems**

Transform your garage into a smart space that perfectly complements your modern home.



SCAN HERE
to see how it works



Available on the
App Store



Google Play Google Home alexa

TAKE CONTROL

Your Garage Door, but Smarter.

No more second-guessing. Just tap, check, and relax. With the Somfy Controller, your garage door is always in your hands, whether you're home or miles away.

Feel secure

Know your garage is shut, even when life gets busy.

Stay in control

Open or close with a tap, or let smart scheduling do the work.











No hassle, just ease

A simple upgrade for a home that works for you.











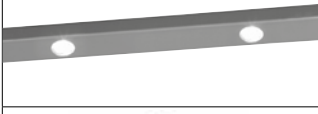

POWERED by
somfy

GARAGE DOOR ACCESSORIES

Images not to scale.	Product code	Accessory	Novomatic compatible	NovoPort® compatible	Price
	OP00030	Signal 218 - Wireless Coded Keypad 10 codes, 433 MHz, KeeLoq rolling code with stainless steel cover, backlit in UV-resistant material	•	•	£120
	OP00025	Singal 107 Push button rocker switch, 1 channel, 7m wired connection	•	•	£40
	OP00031	Signal 111 - Wireless Remote Wall Switch 2-channel, 433 MHz, KeeLoq rolling code for controlling 2 operators or 1 operator and 1 outside lighting in UV-resistant material	•	•	£90
	OP00120	Novoferm Sectional Easy Clip Photocell Kit 10-30 V, IP 44 Range: 7m Suitable for: Novomatic 443 / 573 S, NovoRol NR-20, NovoPort	•	•	£105
	OP00088	Extra 626 - Through-beam Photocells 20-28 V, IP 50 Range: 8m Suitable for: Novomatic 443 / 573 S, NovoRol NR-20, NovoPort	•	•	£105
	OP00004	ZS20 1 Piece Novomatic Boom Suitable for: Novomatic 443 / 573 S, NovoRol NR-20, NovoPort	•		£250
	OP00005	ZS40 2 Piece Novomatic Boom Suitable for: Novomatic 443 / 573 S, NovoRol NR-20, NovoPort	•		£320
	OP00033	Telescopic Operator Bracket Fixes the operator securely when fitted to the top of Novoferm sectional doors	•		£42
	OP00034	Extra 304 - External Manual Release For Novoferm sectional doors fitted with a handle	•	•	£40
	OP00035	Extra 305 - External Manual Release Round cylinder for Novoferm sectional doors fitted without a handle	•	•	£40
	OP00036	Extra 312 - External Manual Release For Novoferm up & over garage doors	•		£35

GARAGE DOOR ACCESSORIES

Images not to scale	Product code	Accessory	Novomatic compatible	NovoPort® compatible	Price
	OP00038	External Adjustment Receiver E43-U, 1-channel, 12-24V, 433MHz Allows Novoferm handsets to be used on additional operators. eg gates, lights etc.	•	•	£102
	OP00041	Extra 412 - Wicket Door Contact For Novoferm sectional garage doors with a wicket door installed	•	•	£150
	OP00042	LED Lighting Kit Up to 3000mm door width	•	•	£550
	OP00043	LED Lighting Kit Up to 4000mm door width	•	•	£600
	OP00044	LED Lighting Kit Up to 5000mm door width	•	•	£650
	OP00019	Mini Novotron 502 Hand Transmitter 2-channel, 433 MHz, KeeLoq rolling code	•	•	£45
	OP00020	Mini Novotron 504 Hand Transmitter 4-channel, 433 MHz, KeeLoq rolling code	•	•	£50
	OP00021	Micro Novotron 512 Hand Transmitter 2-channel, 433 MHz KeeLoq rolling code Small profile handset for key rings	•	•	£55
	OP00023	Novotron Handset clip For Novotron 502 & 504 handsets			£14
	OP00068	Novomatic Receiver Card 433MHz Suitable for: Novomatic 443 / 573 S, NovoRol NR-20, NovoPort	•	•	£70
	OP00024	For Novotron 512 handsets			£14

GARAGE DOOR ACCESSORIES

Images not to scale	Product code	Accessory	Novomatic compatible	NovoPort® compatible	Price
	OP00077	Mini-Novotron 522 hand transmitter 2-channel, 433 MHz, KeeLoq rolling code	•	•	£50
	OP00079	Mini-Novotron 524 hand transmitter 4-channel, 433 MHz, KeeLoq rolling code	•	•	£55
	OP00078	Mini-Novotron 522 Design hand transmitter 2-channel, 433 MHz, KeeLoq rolling code	•	•	£75
	OP00080	Mini-Novotron 524 Design hand transmitter 4-channel, 433 MHz, KeeLoq rolling code	•	•	£80
	OP00086	Wall mounting/silicon case hand transmitter Suitable for use as case and wall mounting for Mini-Novotron 522 Design/524 Design and for Mini-Novotron 522/524			£14
	OP00091	Novomatic Receiver Card 868MHz Suitable for: Novomatic 443 / 573 S, NovoRol NR-20, NovoPort	•	•	£70
	OP00092	868MHz Hand Transmitter Black Design 3-channel, 868 MHz, KeeLoq rolling code	•	•	£95
	AZAD1080	De-Latch for Novoferm retractable lifting up & over doors Suitable for 2 point rigid bar and cable locking systems, supplied with complete locking de-latching system	•		£200
	OP00082	Novomatic 423 with battery Back-up (Accu) 423 operator complete with Battery back-up system that will temporarily keep your garage door in full operation during a power cut.			£750

GARAGE DOOR ACCESSORIES

Images not to scale	Product code	Accessory	Novomatic compatible	NovoPort® compatible	Price
	OP00084	Solar Module For Novomatic 423 with battery back-up (Accu)	•		£250
	OP00085	Rear Boom Support For installations of Novomatic 443 / 573 S operators when fitted to retractable up & over doors. reduces noise and reverberation.	•		£36
	OP00126	NR-20 Bottom Slat Transmitter - RSE Residential-Set Wireless safety edge transmitter for Novoferm insulated roller shutters. Compatible with Novorol NR-20.			£120
	OP00007	Novorol NR-20 Control Unit Control unit for insulated roller shutter doors, for wired safety edges.			£370
	RCXX006SMF	Somfy Rollixo RTS Control Panel Control Panel for insulated roller shutter doors, for wired safety edges.			£350
	OP00130	Somfy Keygo 4 RTS 4 channel, 433MHz.			£70
	OP00132	Somfy Wall RTS Wireless 3 channel, 433MHz.			£70
	OP00133	Somfy Connectivity Kit Easily control your Somfy operators by app and voice. Works with Google Home & Alexa.			£150
	OP00134	Somfy Keypad 2 RTS Wireless Secure coded entry for Somfy operators.			£140
	OP00135	Somfy Reflective Photocell Kit 24 VAC/DC, IP 67 Range: 12m Suitable for: Somfy Rollixo RTS Control Panel Wires not included, Class II - Double insulation			£130

Technical Guides and Information



Intelligent Door Solutions

Contents

Single Up and Over Garage Doors	46-49
Double Up and Over Garage Doors	50-51
Steel Matching Side Doors	52
Steel Side Hinged Doors	53-54
Duoport Insulated Side Hinged Doors	55
Sectional Doors	56-59
Sectional Matching Side Doors	60
Novorol Insulated Roller Doors	61
Ordering	62
Warranty	63

UP AND OVER GARAGE DOORS CANOPY GEAR TYPE (HEIGHT)

Door Width			=H1+50	= H1-20	= H1-90				
Imp	mm	H1	H2	H3	H4	H5	H6	R	C
6'4"	1931	1931	1981	1911	1841	1300	49	675	625
6'6"	1981	1981	2031	1961	1891	1300	49	725	657
6'10"	2085	2085	2135	2065	1995	1300	49	825	775
7'0"	2134	2134	2184	2114	2044	1300	49	880	825

For Maximum and Minimum Door Sizes refer to the current Price List

H1 = Internal Frame Height

H2 = Minimum Height from floor to underside of ceiling

H3 = Minimum Brickwork Opening Height

H4 = Clear Drive Through Height (Internal Handle is the lowest point)

H5 = How far the door extends into the garage

H6 = Kick Up (The height above the Internal Frame Height the door panel rises during the opening cycle)

R = The Arc of travel of the bottom edge of the door

C = The canopy (How far the door protrudes from the frame front)

Note: The Kick up is greater than the frame Lintel Height and peeks above the Lintel at 1100mm into the garage from the frame front

Frame Header Dimensions 45mm High x 40mm Deep

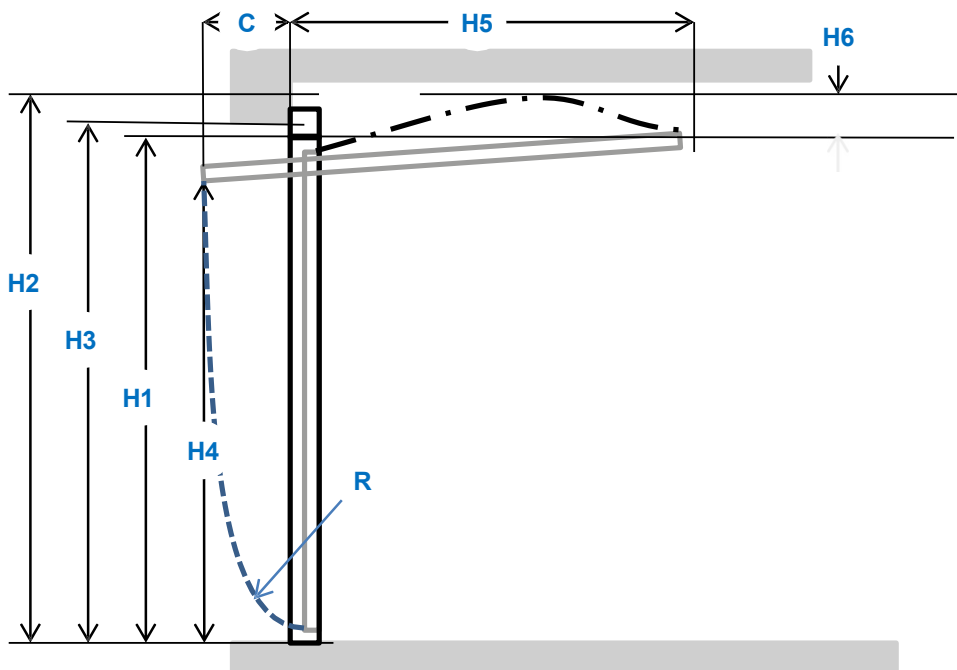

UP AND OVER GARAGE DOORS CANOPY GEAR TYPE (WIDTH)

Door Width		Common Dimensions			54mm Wide x 40mm Deep Frames	
		=W1	=W1+24	=W1+108	=W1+114	
Imp	mm	W1	W2	W4	W5	2199
6'10"	2085	2085	2085	2109	2193	2199
7'0"	2134	2134	2134	2158	2242	2248
7'3"	2210	2210	2210	2234	2318	2324
7'5"	2261	2261	2261	2285	2369	2375
7'6"	2286	2286	2286	2310	2394	2400
8'0"	2438	2438	2438	2462	2546	2552

For Maximum and Minimum Door Sizes refer to the current Price List

- W1 = Internal Frame Width
- W2 = Clear Drive through Width
- W3 = Minimum Brickwork Opening
- W4 = External Frame Width
- W5 = Recommended Brickwork Opening Width

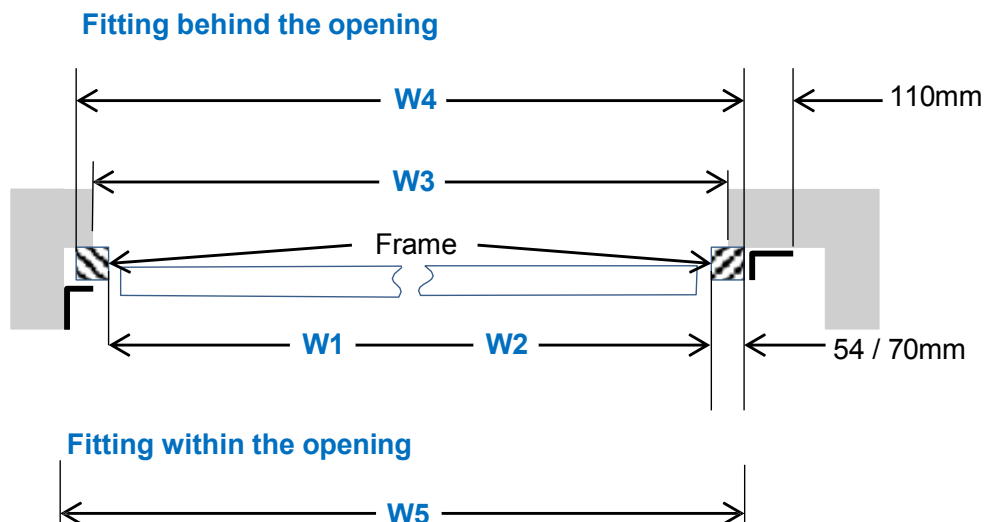

SINGLE UP AND OVER GARAGE DOORS RETRACTABLE GEAR TYPE (HEIGHT)

For Doors With Frame Header 45mm High and 40mm Deep (Steel Doors)

Door Height			=H1+45	Fitting to Return = H1	Fitting Between = H1+50	=H1-150				Lever Arm Crank Height
Imp	mm	H1	H2	H3R	H3B	H4	H5	R	C	
6'6"	1981	1981	2026	1981	2031	1831	1735	1020	225	1030
7'0"	2134	2134	2180	2134	2184	1984	1890	1100	265	1100
7'2+	2200	2200	2245	2200	2250	2050	1965	1140	305	1140

For Doors With Frame Header 68mm High and 60mm Deep (Steel Doors)

Door Height			=H1+68	Fitting to Return = H1	Fitting Between = H1+73	=H1-100				Pivot Arm Crank Height
Imp	mm	H1	H2	H3R	H3B	H4	H5	R	C	
6'6"	1981	1981	2049	1981	2054	1881	1880	880	40	1050
7'0"	2134	2134	2202	2134	2177	2034	1880	1030	230	1200
7'2+	2200	2200	2268	2200	2273	2100	1880	1090	260	1265

- H1 = Internal Frame Height
- H2 = External Frame Height
- H3 = Minimum Brickwork Opening Height
- H4 = Clear Drive Through Height (Internal Handle is the lowest point)
- H5 = How far the door extends into the garage
- R = The arc of travel of the bottom edge of the door
- C = The canopy (How far the door protrudes from the frame front)

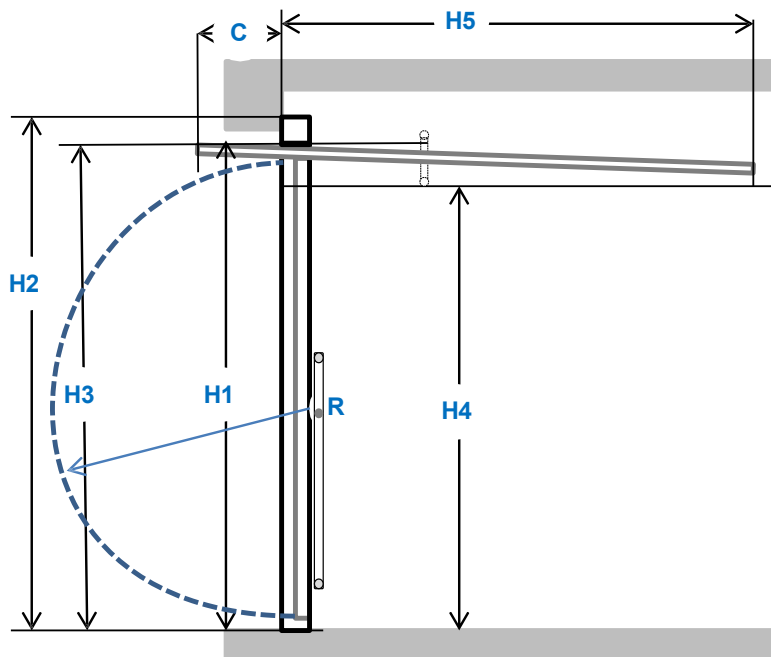

Tolerance:-
 Height = 25mm
 (Typically, Split 12 / 13mm
 Top / Bottom)

 (The difference between the
 Actual Door Panel and the
 Internal Frame Dimensions)

SINGLE UP AND OVER GARAGE DOORS RETRACTABLE GEAR TYPE (WIDTH)

Door Height		Common Dimensions				70mm Wide Frame		For GRP Doors 68mm Wide Frame	
		=W1+24	=W1-100	=W1-36	=W1+140	=W1+160	=W1 + 136	=W1 + 146	
Imp	mm	W1	W2	W3A	W3B	W4	W5	W4	W5
6'10"	2085	2085	2109	1985	2049	2225	2245	2221	2231
7'0"	2134	2134	2158	2034	2098	2274	2294	2270	2280
7'3"	2210	2210	2234	2110	2174	2350	2370	2346	2356
7'5"	2261	2261	2285	2161	2225	2381	2421	2397	2407
7'6"	2286	2286	2310	2186	2250	2426	2446	2422	2432
8'0"	2438	2438	2462	2338	2402	2580	2598	2574	2584
9'0"	2743	2743	2767	2643	2707	2883	2903	N / A	N / A
10'0"	3048	3048	3072	2948	3011	3188	3208	N / A	N / A

W1 = Internal Frame Width

W2 = Minimum Brickwork Opening

W3A = Clear Drive through Width – Above the Crank of the Pivot Arm

W3B = Clear Drive through Width – Below the Crank of the Pivot Arm

W4 = External Frame Width

W5 = Recommended Brickwork Opening Width

NOTE – The crank in the pivot arm is 1000mm from the floor on a 1981mm high door 1100mm from the floor on a 2134mm high door

NOTE – When the Side Wall is more than 400mm away from the opening aperture then use NFSP 0501 “Adjustable Track Hanging Kit” this allows the tracks to be hung from the rafters above

Fitting behind the opening

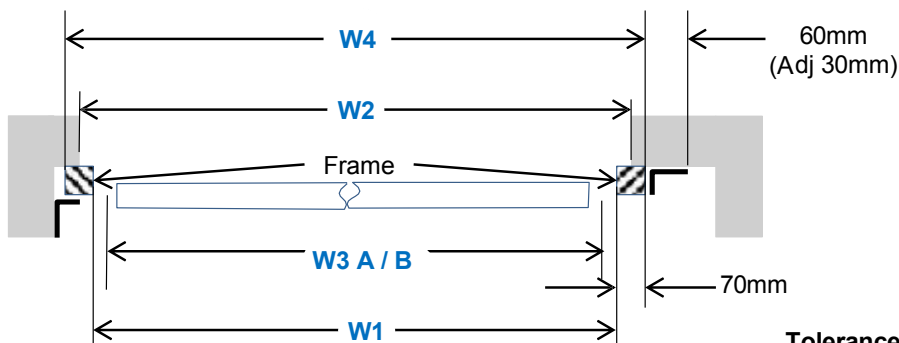

Tolerance:-

Width Framed Doors = 8mm

Width Un-Framed Doors = 18mm

Fitting within the opening

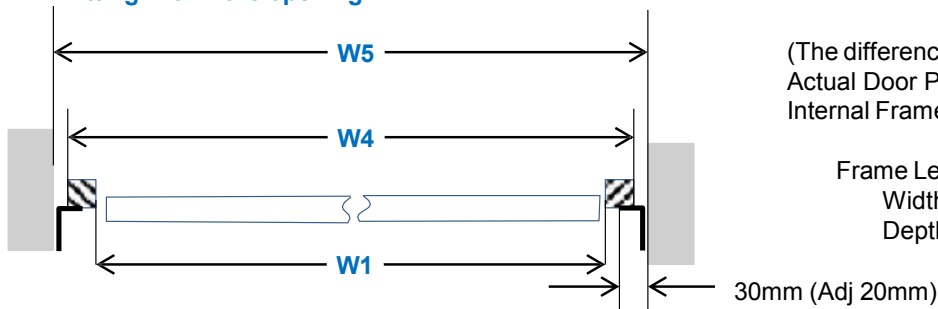

(The difference between the Actual Door Panel and the Internal Frame Dimensions)

Frame Leg Dimensions

Width = 70mm

Depth = 40mm

DOUBLE UP AND OVER GARAGE DOORS RETRACTABLE GEAR TYPE (HEIGHT)

Door Height			=H1+68	=H1	=H1-150				
Imp	mm	H1	H2	H3	H4	H5	R	C	T
6'6"	1981	1981	2048	1981	1831	1870	900	60	1903
7'0"	2134	2134	2202	2134	1984	1870	1040	210	2055
7'6"	2286	2286	2354	2286	2136	1870	1180	360	2207
8'0"	2438	2438	2506	2438	2288	1870	1320	510	2359

H1 = Internal Frame Height

H2 = External Frame Height

H3 = Minimum Brickwork Opening Height

H4 = Clear Drive Through Height (Internal Handle is the lowest point)

H5 = How far the door extends into the garage

R = The arc of travel of the bottom edge of the door

C = The canopy (How far the door protrudes from the frame front, Assumes 70mm thick frame)

T = Horizontal Track Height, Measured from the floor to the lower edge of the horizontal track by the frame, the rear end of the track should be 50mm lower than the front

K = Kick up = 43mm

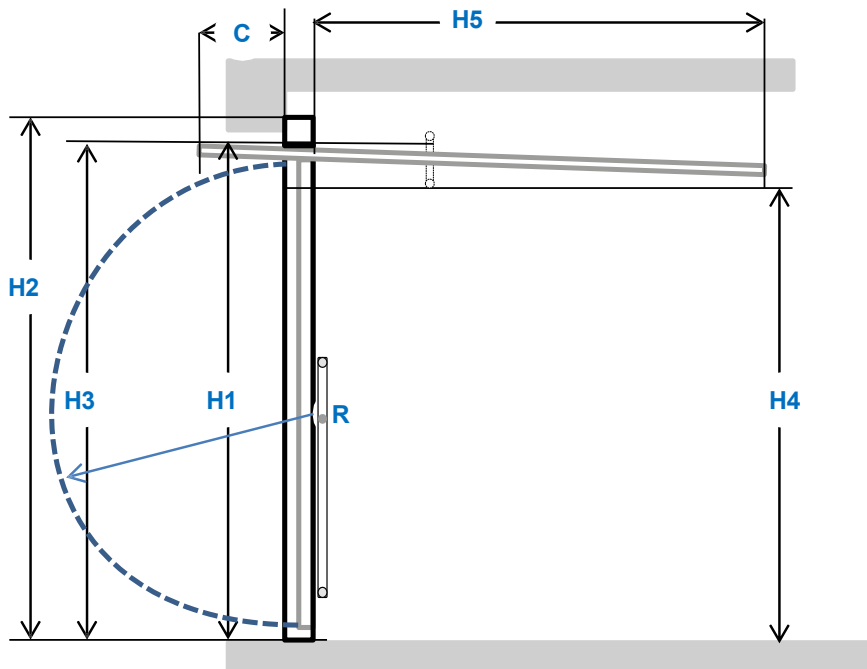

Frame Header Dimensions
Height = 68mm
Depth = 75mm

DOUBLE UP AND OVER GARAGE DOORS RETRACTABLE GEAR TYPE (WIDTH)

Door Height		Common Dimensions				70mm Wide Frame	
		=W1+24	=W1-120	=W1-50	=W1+140	=W1+150	
Imp	Mm	W1	W2	W3A	W3B	W4	W5
8'0"	2438	2438	2462	2318	2388	2578	2588
10'0"	3048	3048	3072	2928	2998	3188	3198
12'0"	3657	3657	3682	3538	3607	3797	3807
14'0"	4267	4267	4291	4147	4217	4407	4417
16'0"	4877	4877	4901	4757	4827	5017	5027

For Maximum and Minimum Door Sizes refer to the current Price List

- W1 = Internal Frame Width
- W2 = Minimum Brickwork Opening (When Fitted Behind the Opening)
- W3A = Clear Drive through Width – Above the Bottom of the Pivot Arm
- W3B = Clear Drive through Width – Below the Bottom of the Pivot Arm
- W4 = External Frame Width
- W5 = Recommended Brickwork Opening Width (When Fitting within the opening)

NOTE – The Bottom of the Pivot Arm when the door is open is
 820mm from the floor on a 1981mm high doors
 970mm from the floor on a 2134mm high doors
 1120mm from the Floor on a 2286mm high doors

The Door panel is 20mm smaller than the Internal Frame Size

Fitting behind the opening

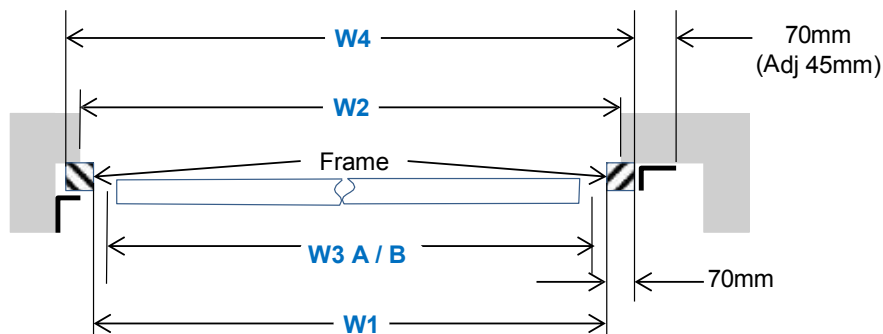

Fitting within the opening

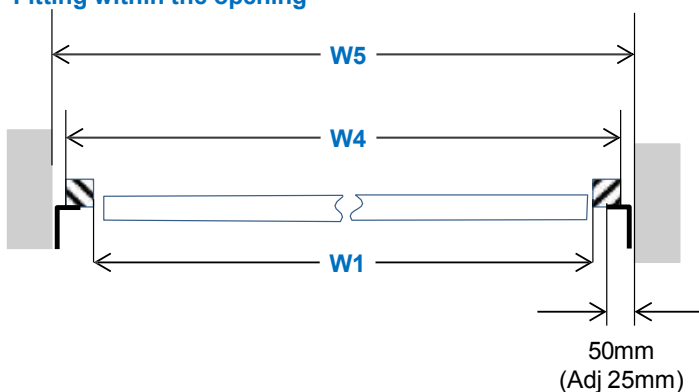

Frame Leg Dimensions
 Width = 70mm
 Depth = 75mm

STEEL MATCHING SIDE DOORS

SIDE HINGE GEAR TYPE

Door Width			=W1+100	= W1+110	= W1-20
Imp	mm	W1	W2	W3	W4
2'10 1/2"	875	875	1011	1021	820
3'3 1/3"	1000	1000	1136	1146	945

(To match Steel Up & Over Doors)

- W1 = Internal Frame Width
- W2 = External Frame Width
- W3 = Recommended Brickwork Opening Width
 - Fitting between the brickwork
- W4 = Clear Walk through Width
 - Door Open to 90 Degrees

Frame Leg Dimensions
- 50mm Wide – 63mm Deep

Inward Opening Doors - variations

W4 – Clear Walk through Width = Internal Frame Width – 65mm

H4 – Clear Walk through Height = Internal Frame Height – 15mm

Note:

When fitting behind the brickwork the Internal Frame Width should be = Brickwork Opening - 40mm
This is because the Hinge Knuckle overhangs the frame and needs allowing for.

Fitting within the opening

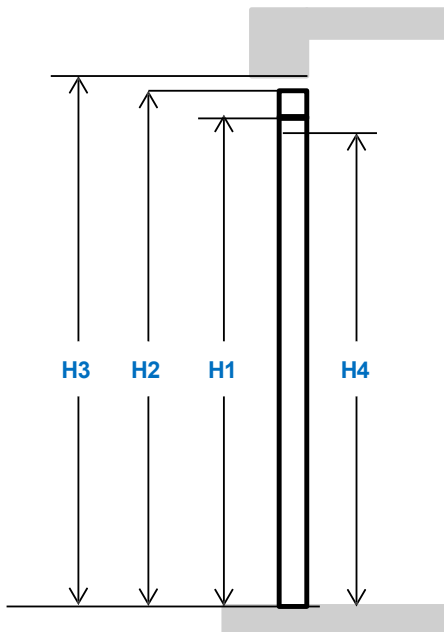
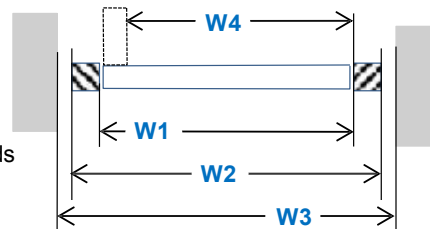

Door Height			=H1+50	=H1+55	=H1-20
Imp	mm	H1	H2	H3	H4
6'2"	1875	1875	1925	1930	1855
6'6"	2000	2000	2050	2055	1980
7'0"	2125	2125	2175	2180	2115

- H1 = Internal Frame Height
- H2 = External Frame Height
- H3 = Minimum Brickwork Opening Height
- H4 = Clear Walk through Height (Lowest point, Internal Weather Bead)

Frame Lintel Dimensions
- 50mm High; 63mm Deep

Doors to be ordered by External Frame Size or Brickwork Opening Dimensions

STEEL SIDE HINGED GARAGE DOORS (HEIGHT)

Standard Height Doors Only

Door Height		H1	H2	H3	H4	H5
Imp	mm					
6'6"	1981	1981	2031	2036	1866	1806
7'0"	2134	2134	2184	2189	2119	2059
7'6"	2286	2286	2336	2341	2271	2211

Special Height Doors

Door Height		H1	H2	H3	H4	H5
From	To					
	1980	H1	H1+50	H1+55	H1-15	H1-75
1982	2133	H1	H1+50	H1+55	H1-15	H1-75
2135	2285	H1	H1+50	H1+55	H1-15	H1-75

For Maximum and Minimum Door Sizes refer to the current Price List

H1 = Internal Frame Height

H2 = External Frame Height

H3 = Minimum Brickwork Opening Height

H4 = Clear Drive Through Height – Internal Weather Seal, Lower Edge

H5 = Clear Drive Through Height – When Door Stays are Installed (Locally, Edges of Opening)

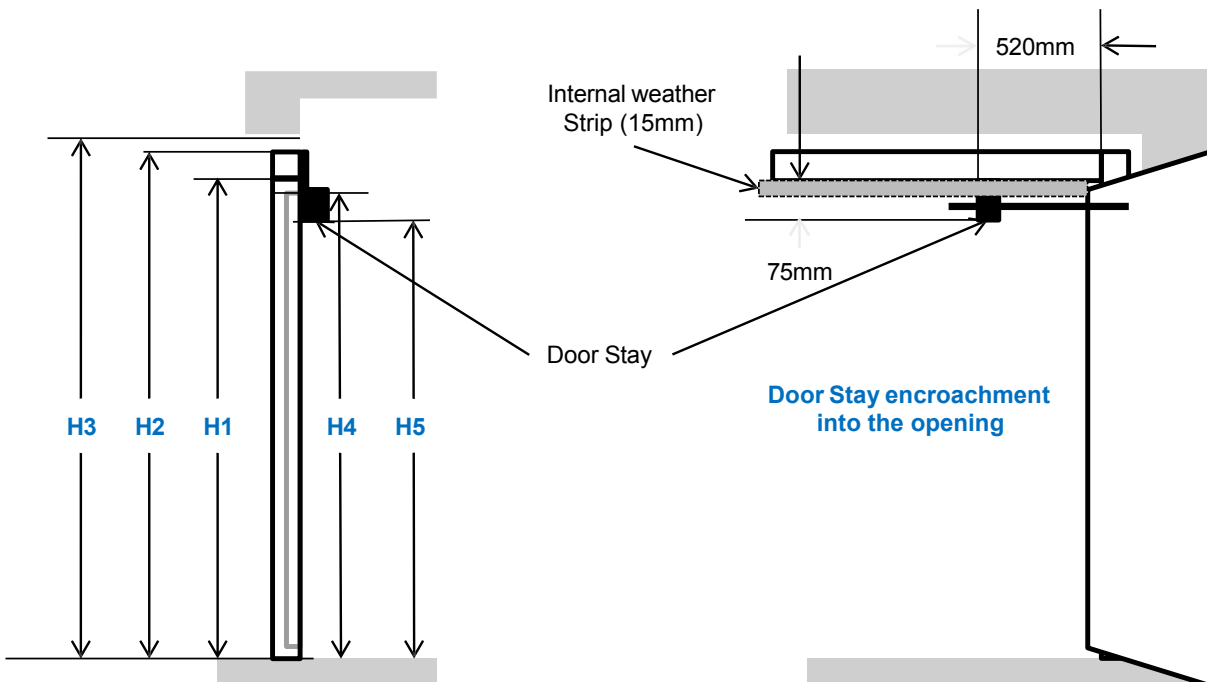

STEEL SIDE HINGED GARAGE DOORS (WIDTH)

Door Width		Common Dimensions				50mm Wide Frame	
		=W1+10	= W1-100	= W+100	= W+110	= W+20	
imp	mm	W1	W2	W3	W4	W5	W6
6'6"	1981	1981	1991	1881	2081	2091	2001
7'0"	2134	2134	2144	2034	2234	2294	2154
7'6"	2286	2286	2296	2186	2386	2446	2306
8'0"	2438	2438	2448	2338	2538	2598	2458

For Maximum and Minimum Door Sizes refer to the current Price List

- W1 = Internal Frame Width
- W2 = Minimum Brickwork Opening
- W3 = Clear Drive through Width – Door Open to 90 Degrees
- W4 = External Frame Width
- W5 = Recommended Brickwork Opening Width – Fitting between the brickwork
- W6 = Recommended Brickwork Opening Width – Fitting behind the brickwork

Fitting within the opening (Recommended)

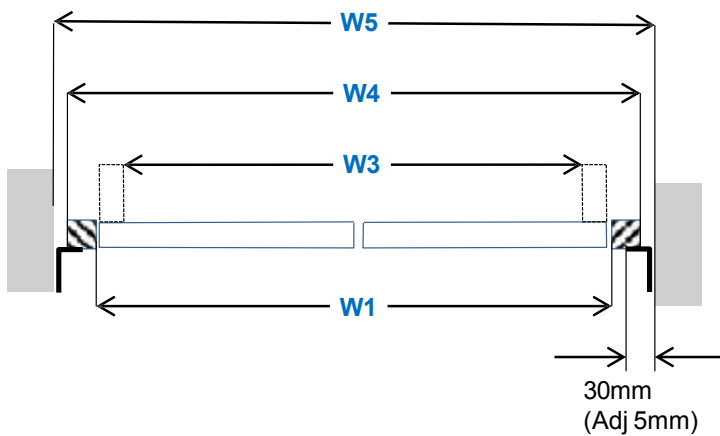

Fitting behind the opening

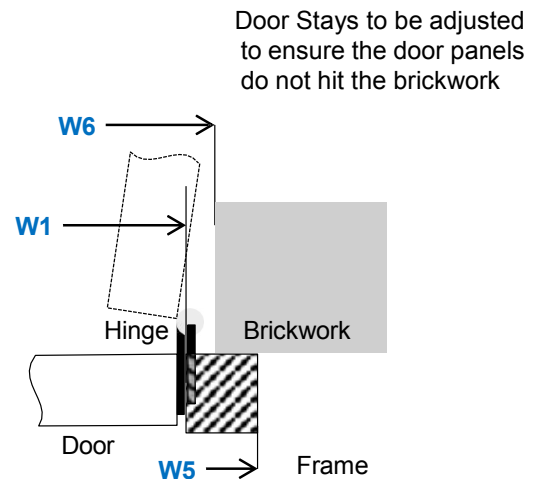
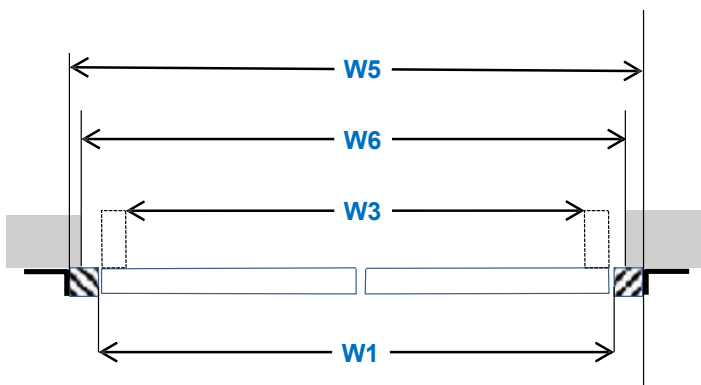

DUOPORT INSULATED SIDE HINGED GARAGE DOORS

STANDARD DOOR WIDTHS

Door width			=W1+144	=W1+154	=W1-116
imp	mm	W1	W2	W3	W4
6'6"	1981	1981	2125	2135	1865
7'0"	2134	2134	2278	2288	2018
7'6"	2286	2286	2430	2440	2170
8'0"	2438	2438	2582	2592	2322

W1 = Internal Frame Width

W2 = External Frame Width

W3 = Recommended Brickwork Opening Width - Fitting between the brickwork

W4 = Clear Drive through Width - Door Open to 90 Degrees
Frame Leg Dimensions - 72mm Wide - 70mm Deep

Order by Brickwork Opening Dimensions or External Frame Size Required

Fitting within the opening

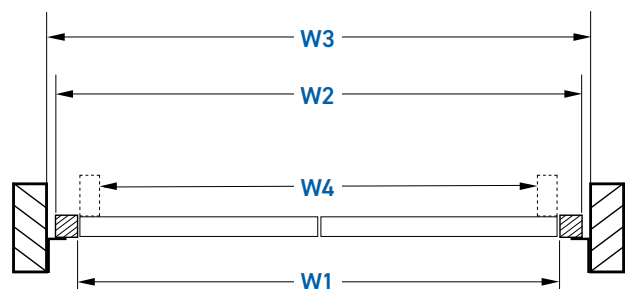

STANDARD DOOR HEIGHTS

Door Height			=H1+72	=H1+77	=H1
imp	mm	H1	H2	H3	H4
6'6"	1981	1981	2053	2058	1981
7'0"	2134	2134	2206	2211	2134
7'6"	2286	2286	2358	2363	2286

H1 = Internal Frame Height

H2 = External Frame Height

H3 = Minimum Brickwork Opening Height

H4 = Clear Drive through Height (Internal Weather Seal is the lowest point)
(Door stay if fitter are lower locally by 60mm)

Frame Header Dimensions - 72mm High - 70mm Deep

Floor Threshold - 19mm High

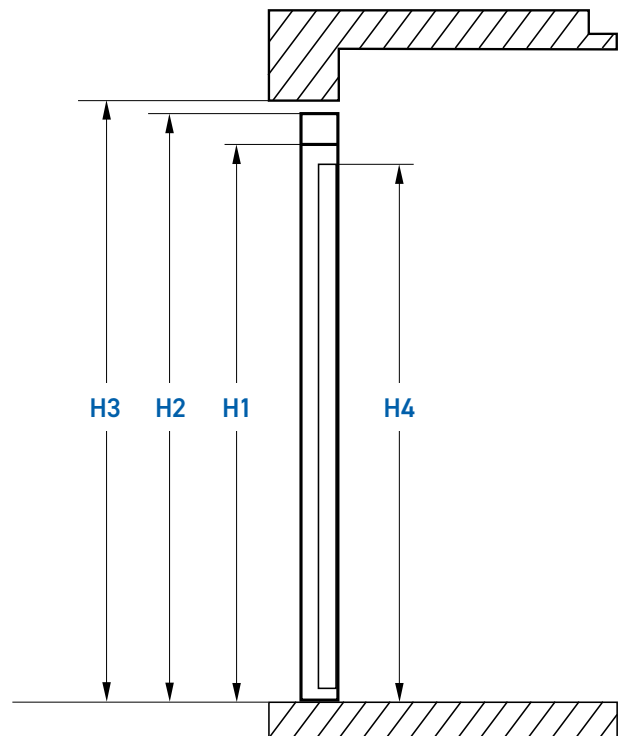

ISO45 & 20 OVERHEAD SECTIONAL GARAGE DOORS E® SPRING UP TO 3000MM WIDE X 2700MM HIGH

iso45 sizes above 3000mm x 2700mm are supplied with front mount torsion spring as standard.
All sectional doors including wicket doors are supplied with front mount torsion spring as standard.

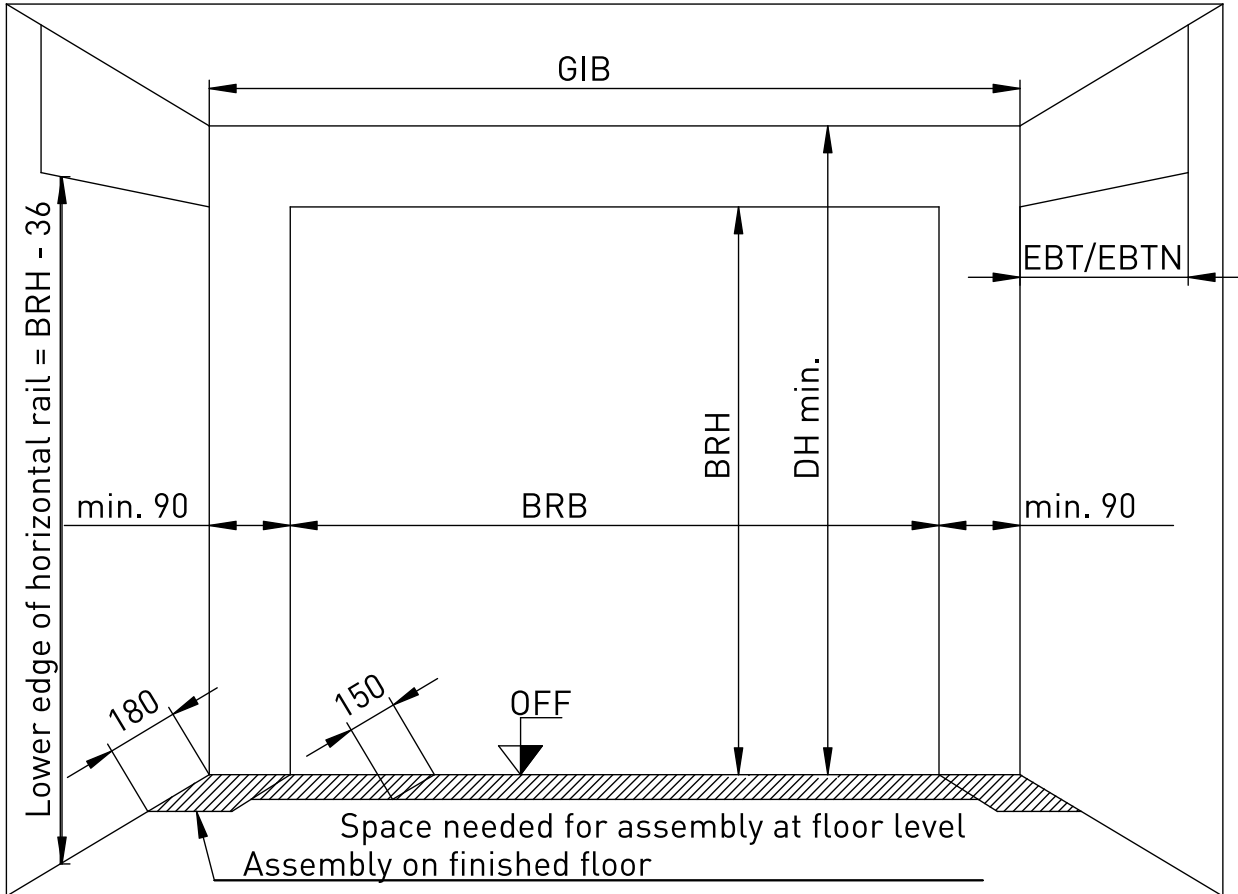

REQUIRED INSTALLATION DIMENSIONS

- BRB = Coordinating width (order size)
- BRH = Coordinating height (order size)
- DH = Ceiling height (minimum dimension)
- GIB = Interior garage width (minimum dimension)
- EBT = Installation depth of the door
- EBTN = Installation depth of garage door with Novomatic operators
- RAMB = Outer frame width
- RAMH = Outer frame height
- OFF = Upper-edge finished floor
- LDH = Clear passage height

Please consult the "Coordinating widths and heights" chart or calculate the dimensions based on the drawings.

If the structure does not have the required minimum dimensions, it can be compensated by fitting panels and profiles.

All dimensions in mm.

ISO45 & 20 OVERHEAD SECTIONAL GARAGE DOORS E® SPRING UP TO 3000MM WIDE X 2700MM HIGH

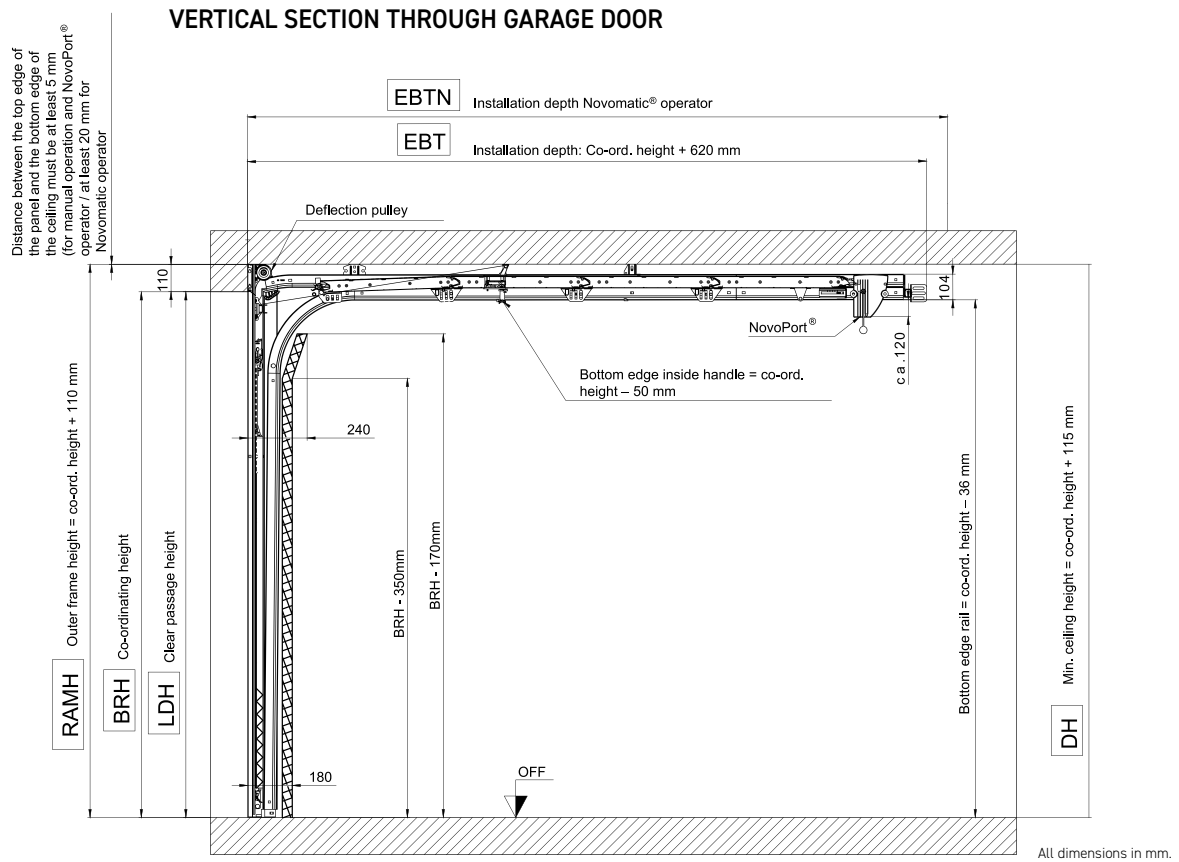

HORIZONTAL SECTION THROUGH GARAGE DOOR

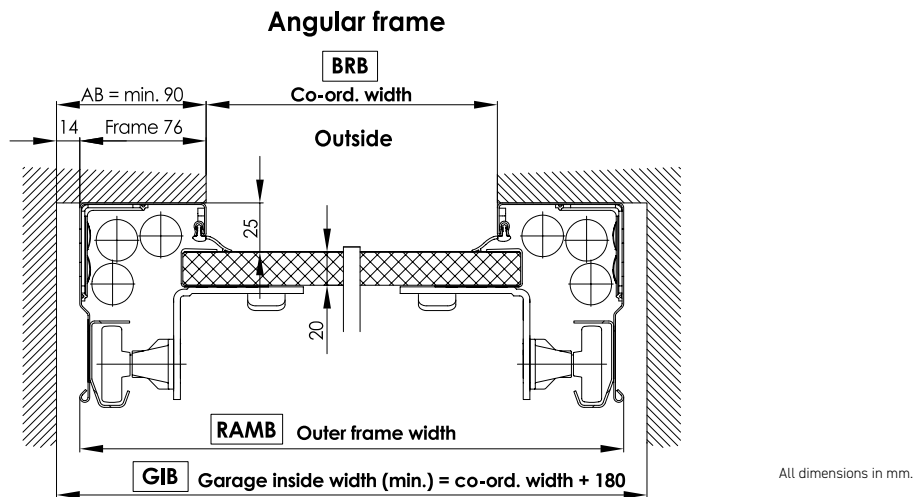

ORDERING INFORMATION

To calculate the correct door order size to fit within a structural opening, deduct 180mm from the width and 120mm (rear mount) or 215mm (front mount) from the height. For behind the reveal fit calculate from drawings (using required headroom for front/rear mount).

ISO45 OVERHEAD SECTIONAL GARAGE DOORS

TORSION SPRINGS REAR MOUNTED TORSION SPRING DETAIL

ALL DOORS WITH WICKET DOORS HAVE TORSION SPRINGS

FITTING WITHIN THE OPENING

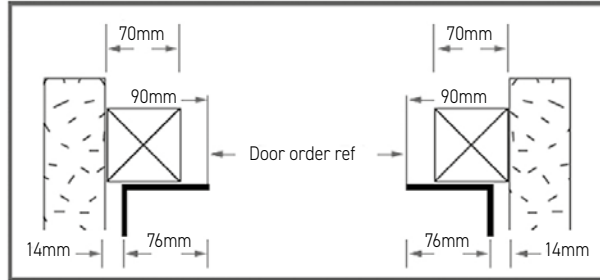
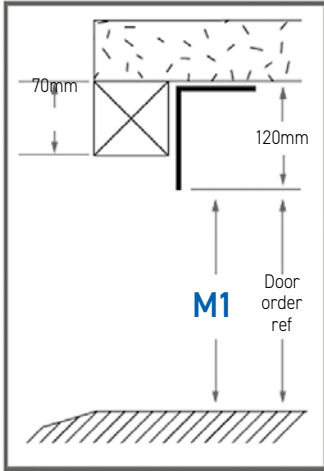

Order ref height	Standard size heights			
	M1	M2	M3	M4
6'4"	1925	2045	2050	2690
6'6"	2000	2120	2125	2765
6'10"	2075	2195	2200	2840
7'0"	2125	2245	2250	2890

CPH Clear Passage Height
(with NovoPort®)
COH (M1) Co-ord Height
OFH (M2) Outer Frame Height
CH (M3) min. Ceiling Height
ID (M4) min. Installation Depth

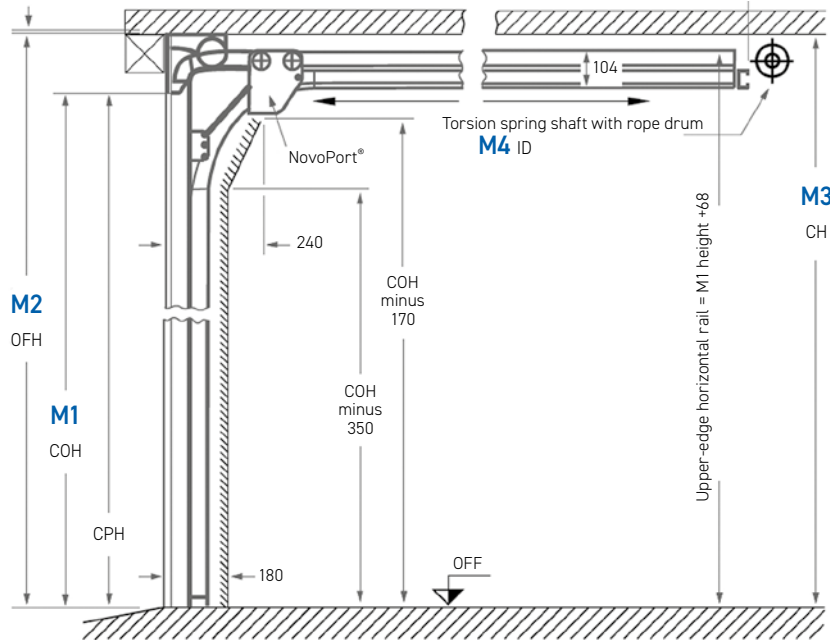

ISO45 OVERHEAD SECTIONAL GARAGE DOORS

TORSION SPRINGS FRONT MOUNTED TORSION SPRING DETAIL

FITTING BEHIND THE OPENING

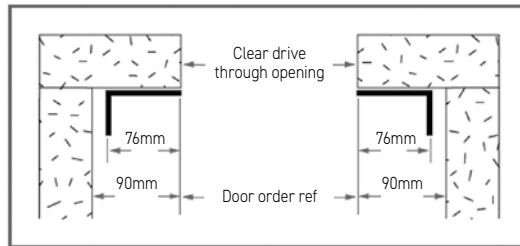
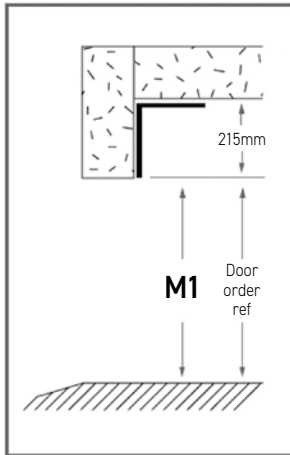

Order ref height	Standard size heights			
	M1	M2	M3	M4
6'4"	1925	2140	2145	2505
6'6"	2000	2215	2220	2580
6'10"	2075	2290	2295	2655
7'0"	2125	2340	2345	2705

CPH Clear Passage Height (with NovoPort®)
 COH (M1) Co-ord Height
 OFH (M2) Outer Frame Height
 CH (M3) min. Ceiling Height
 ID (M4) min. Installation Depth

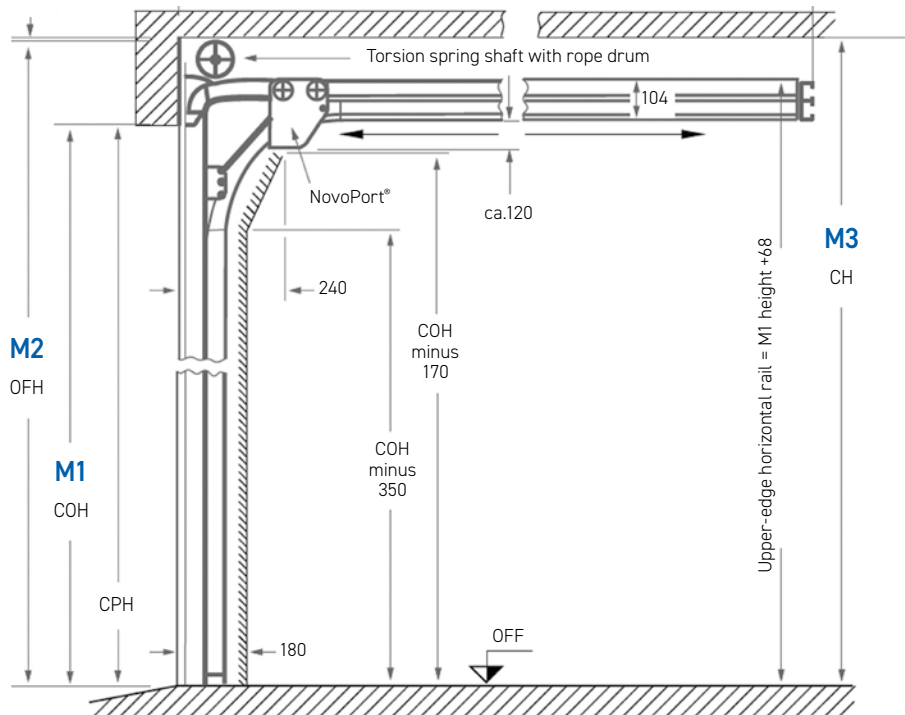

SECTIONAL MATCHING SIDE DOORS

Horizontal Cut (Installation behind the opening)

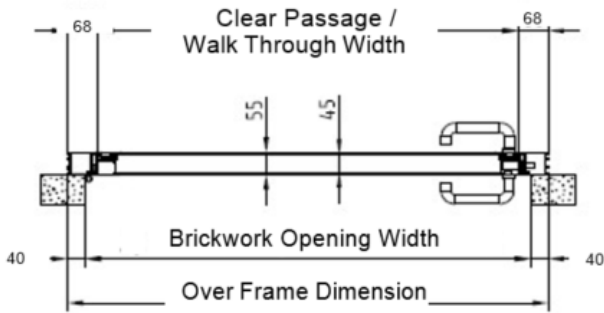

Horizontal Cut (Installation behind the opening)

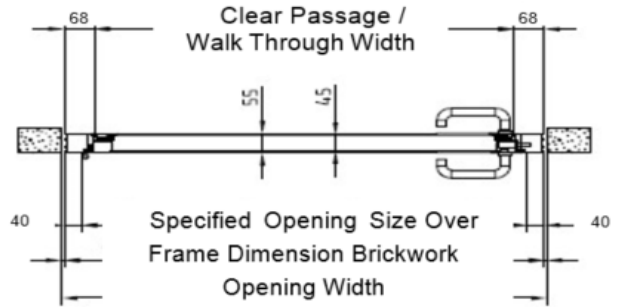

Vertical Cut (Installation behind the opening)

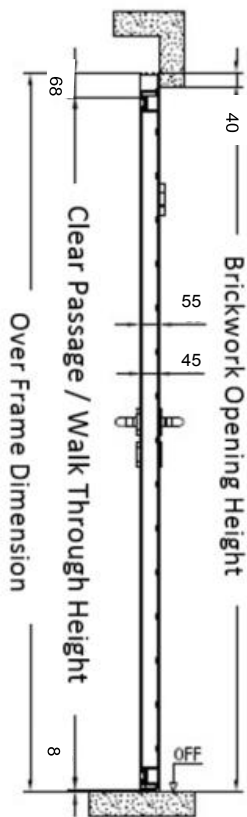

Vertical Cut (Installation in the opening)

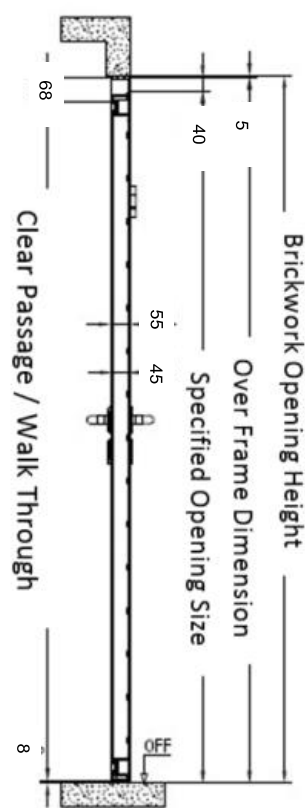

Note: The "Clear Passage / Walk through width" shown is the internal dimensions of the frame and does not allow for the thickness of the door panel when it is fully open, reducing the actual walk through width by the thickness of the door, 50mm.

NOVOROL INSULATED ROLLER DOORS

Door Height		Over Guide Width (mm)						Hang Down (mm)
		2000	2500	3000	4000	4500	5000	
Guide Widths	55mm Laths	65mm	65mm	65mm	N/A	N/A	N/A	50mm
	77mm Laths	70 or 90mm	70 or 90mm	70 or 90mm	90mm	90mm	90mm	50mm

Box Sizes - Novorol 77 – Doors below 2300mm in height will be supplied with a 300mm box. Doors above 2300mm height will come supplied with a 360mm box. **Novorol 55** – Doors supplied with 205mm full box

Fitting Within the Aperture / between the walls / between the reveal

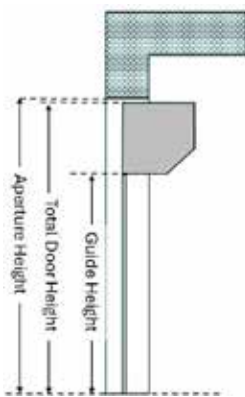

Guide Positioning

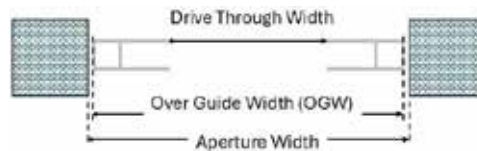

When installing doors where some / all of the Front 90 Deg Box is exposed it is recommended that the Rear Box is fitted to protect the Axle / Shaft Assembly and give added security.

Fitting Behind the Aperture

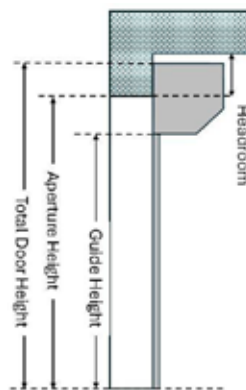
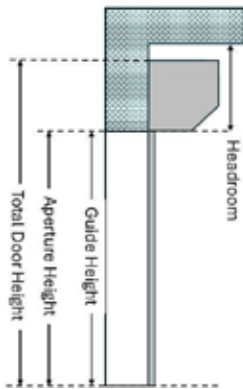

Guide Positioning

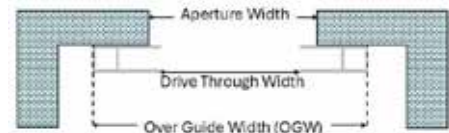

Headroom
Ideally the Headroom available will be greater than the Box Height

Typical Guide Fixing Methods

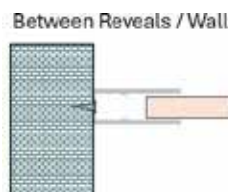
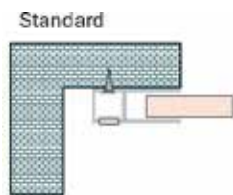

INTERNAL FRAME SIZE (ORDERING SIZE)

TO EXTERNAL FRAME DIMENSIONS FOR UP AND OVER DOORS

Imperial Size	Internal Frame Size	Canopy	Single Retractable	Double Retractable	Side Hinged
ft, in	mm x mm	54mm x 45mm	70mm x 45mm	68mm x 68mm	50mm x 50mm
W x H	W x H	W x H	W x H	W x H	W x H
7'0" x 6'6"	2134 x 1981	2242 x 2026	2274 x 2026	-	2234 x 2031
7'0" x 7'0"	2134 x 2134	2242 x 2179	2274 x 2179	-	2234 x 2184
7'0" x 7'6"	2134 x 2286	2242 x 2331	2274 x 2331	-	2234 x 2336
7'6" x 6'6"	2286 x 1981	2394 x 2026	2426 x 2026	-	2386 x 2031
7'6" x 7'0"	2286 x 2134	2394 x 2179	2426 x 2179	-	2386 x 2184
7'6" x 7'6"	2286 x 2286	2394 x 2331	2426 x 2331	-	2386 x 2336
8'0" x 6'6"	2438 x 1981	2546 x 2026	2578 x 2026	-	2538 x 2031
8'0" x 7'0"	2438 x 2134	2546 x 2179	2578 x 2179	-	2538 x 2184
8'0" x 7'6"	2438 x 2286	2546 x 2331	2578 x 2331	-	2538 x 2336
9'0" x 6'6"	2743 x 1981	-	2883 x 2026	-	-
9'0" x 7'0"	2743 x 2134	-	2883 x 2179	-	-
9'0" x 7'6"	2743 x 2286	-	2883 x 2331	-	-
10'0" x 7'0"	3048 x 2134	-	-	3184 x 2202	-
10'0" x 7'6"	3048 x 2286	-	-	3184 x 2354	-
11'0" x 7'0"	3353 x 2134	-	-	3489 x 2202	-
11'0" x 7'6"	3353 x 2286	-	-	3489 x 2354	-
12'0" x 7'0"	3658 x 2134	-	-	3794 x 2202	-
12'0" x 7'6"	3568 x 2286	-	-	3794 x 2354	-
13'0" x 7'0"	3962 x 2134	-	-	4098 x 2202	-
13'0" x 7'6"	3962 x 2286	-	-	4098 x 2354	-
14'0" x 7'0"	4267 x 2134	-	-	4403 x 2202	-
14'0" x 7'6"	4267 x 2286	-	-	4403 x 2354	-
15'0" x 7'0"	4572 x 2134	-	-	4708 x 2202	-
15'0" x 7'6"	4572 x 2286	-	-	4708 x 2354	-
16'0" x 7'0"	4877 x 2134	-	-	5013 x 2202	-
16'0" x 7'6"	4877 x 2286	-	-	5013 x 2354	-

WARRANTY INFORMATION

The purchaser is granted a warranty covering the safe and reliable functioning of the door. For full warranty details please see our website www.novoferm.co.uk.

PRICES

All orders are accepted on the understanding that the goods will be subject to the price ruling at the time of delivery, unless other terms are specifically agreed.

All prices are in £ sterling and exclude VAT. UK mainland delivery is included to the buyer's trading address - delivery to site is possible (subject to access). See delivery details below.

A 25% handling charge applies to all unwanted items on standard stock items only. Items must be returned unopened and in an unused condition.

All returns are subject to acceptance by the manufacturer of the garage doors.

All doors are bespoke and made to order. Your right to cancel is not available on non-standard made to order doors.

Returns can be collected subject to charge. Contact your Sales Representative for up to date pricing

DELIVERY CHARGES TO SITE

All doors are bespoke and made to order. Your right to cancel is not available on non-standard made to order doors once they have started production, typically 24 hours after receipt of order confirmation.

For delivery charges to site please call our customer service team on **01582 563777**.

A minimum of 24 hours' notice will be given for all deliveries.

Should you require delivery at a later date, please advise at point of order.

SPECIFICATION

Due to the progressive outlook of the manufacturer we reserve the right to alter specifications to design and manufacture without notification.

Where any manufacturer changes affect the aesthetics, feature, or installed functionality of the door, we may seek approval prior to completion of the order.

All specifications and details are correct at the time of publication, errors and omissions excepted. Where any manufacturer changes affect the aesthetics, feature, or installed functionality of the door, we may seek approval prior to completion of the order. Where exact colour matching is a requirement we always recommend obtaining a sample prior to final order confirmation.

For information on colour standards and colour limitation contact the Door and Hardware Federation **dhf** (dhfonline.org.uk)

ALL DOORS

Colour Match

Pairs of doors should be ordered together to obtain the best colour match, bearing in mind the limitations of the materials used in the construction.

For information on colour standards and colour limitation contact the Door and Hardware Federation dhf (dhfonline.org.uk)

Dark colours on garage doors which are exposed to direct sunlight for a considerable period of time should be avoided as they will fade more noticeably due to the strong sunlight.

All colour samples depicted in this brochure are as close to the original manufacturer's colours as possible. Garage doors supplied may vary in colour from the brochure representation due to printing processes. Where exact colour matching is a requirement we always recommend obtaining a sample prior to final order confirmation.

SIZE VARIATIONS

As the size of a door changes in height and/or width, the panel frequency and profile can change, therefore doors of the same style but of different sizes may display a significant difference in appearance.

CLEARANCES

All doors require operating clearances, i.e. the gap between the door panel and frame opening, these are inbuilt during manufacture and should not be reduced by means of infiles, or draught proofing.

DEFLECTION

When in the open position, all doors will display a level of vertical deflection or 'sag' across the width of the panel.

Individual manufacturers' specifications should be consulted for exact tolerances.

CARE AND MAINTENANCE

All doors supplied conform to UK tolerance levels in accordance with UKCA guidelines

In order to get the best from your door, and for your door to be fully covered by the Guarantee, there are some things you will need to do throughout the guarantee cover period, and throughout the life of the door. For full guidance on how to maintain and care for your garage door

Please see our website for full details on how to do this www.novoferm.co.uk



Your Novoferm Stockist



Intelligent Door Solutions

UK
CA



Call Us Now +44 (1582) 563777

Opening times
8.30am - 5.00pm
Monday to Friday

Novoferm UK
Unit 5 - 9 North Luton Industrial Estate
Sedgwick Road
Luton
LU4 9DT
customerservice@novoferm.co.uk
www.novoferm.co.uk